



NE WS 20 24





Line48

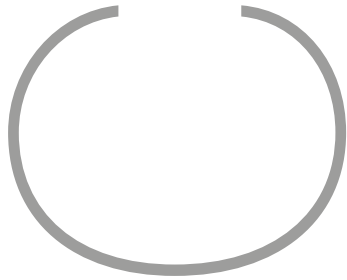

Flex Series



220V Series



LED Strip

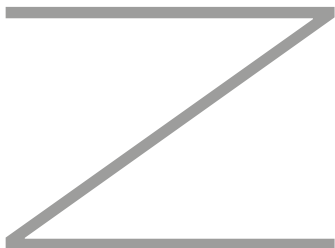

Aluminum Profiles



Plasterboard Profiles

	Dip Switch	8
Binario Magnetico 48V Incasso a Scomparsa - 48V Recessed Magnetic Track		10

Strip LED Flex FL1010 - Flex 1010 LED Strip	15
Strip LED Flex FL916 - Flex 916 LED Strip	16
Strip LED Flex FL1616 - Flex 1616 LED Strip	17
Strip LED Flex FL612 - Flex 612 LED Strip	18
Strip LED Flex FL1018 - Flex 1018 LED Strip	19

	SLP220 Anti Flicker	20
--	----------------------------	-----------

Strip LED COB IP67 - IP67 COB LED Strip	24
Strip LED COB Energy Saving IP67 - IP67 Energy Saving COB LED Strip	25
Strip LED RGB 5mm IP20 - IP20 5mm RGB LED Strip	26
Strip LED RGB.Dati IP20 - IP20 RGB.Data LED Strip	28

PR224/FL - Profilo ad Incasso a Scomparsa Curvabile - Bendable Trimless Recessed Profile	34
PR225/FL - Profilo ad Incasso a Scomparsa Curvabile - Bendable Trimless Recessed Profile	35
PR221/FL - Profilo ad Incasso - Recessed Profile	37
PR270 - Profilo ad Incasso a Scomparsa - Trimless Recessed Profile	39
PR336 - Profilo Angolare - Angular Profile	41
PR620 - Profilo Angolare a Scomparsa - Trimless Angular Profile	43

PG270 - Profilo incassato in Cartongesso - Recessed Profile in plasterboard	46
PG165 - Profilo incassato in Cartongesso - Recessed Profile in plasterboard	47
PG166 - Profilo incassato in Cartongesso - Recessed Profile in plasterboard	48
PG245 - Profilo incassato in Cartongesso - Recessed Profile in plasterboard	49



LINE48 series



Dip - Switch

Grazie al **Dip-Switch**, sarà possibile personalizzare l'accensione del vostro corpo illuminante in modo semplice e rapido.

Cos'è il Dip-Switch?

Il Dip-Switch è un interruttore a 2 posizioni integrato nei nostri apparecchi di illuminazione **LINE48** così da permettere la scelta tra due modalità di accensione con un semplice gesto, senza bisogno di modifiche o interventi tecnici.

Come funziona?

1. Prima posizione: Impostate il Dip-Switch sulla prima posizione per impostare il corpo illuminante sulla prima accensione.
2. Seconda posizione: Spostate il Dip-Switch sulla seconda posizione per la seconda accensione.

Quali sono i vantaggi?

- Facilità d'uso: Basta un semplice tocco per cambiare l'impostazione.
- Flessibilità: Adattate l'illuminazione alle vostre esigenze senza complicazioni.
- Nessuna modifica necessaria: Godetevi la libertà di scegliere l'accensione ideale senza dover intervenire sul prodotto.

Perché scegliere LINE48 con Dip-Switch?

I nostri apparecchi di illuminazione LINE48 sono già sinonimo di qualità.

Con l'aggiunta del Dip-Switch, vi offriamo ancora più controllo e praticità, per un'illuminazione che si adatta perfettamente ad ogni situazione.

Thanks to the **Dip-Switch**, it will be possible to customize the switching on of your lighting fixture simply and quickly.

What is the Dip-Switch?

The Dip-Switch is a 2-position switch integrated into our **LINE48** lighting fixtures so as to allow the choice between two switching modes with a simple gesture, without the need for modifications or technical interventions.

How does it work?

1. First position: Set the Dip-Switch to the first position to set the lighting body to the first switch-on.
2. Second position: Move the Dip-Switch to the second position for the second switch.

What are the benefits?

- Ease of use: Just a simple touch is enough for changing the setting.
- Flexibility: Adapt the lighting to your needs without complications.
- No modifications necessary: Enjoy the freedom of choosing the ideal switch without having to intervene on the product.

Why choose LINE48 with Dip-Switch?

Our LINE48 lighting fixtures are already synonymous with quality.

With the addition of the Dip-Switch, we offer you even more control and convenience, for lighting that adapts perfectly to every situation.

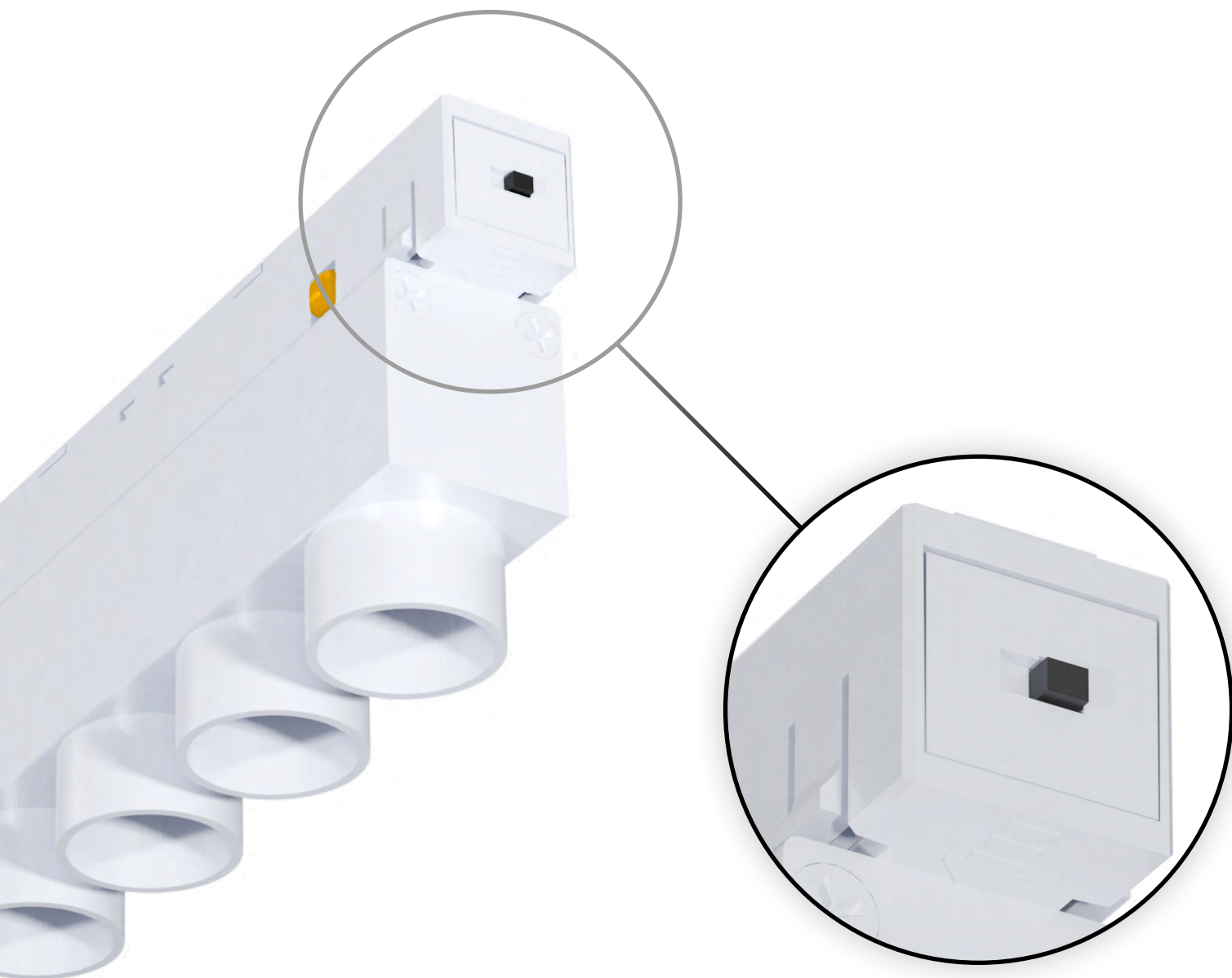



BINARIO 48V - Incasso a Scomparsa

48V TRACK - Trimless recessed

Disponibile da Ottobre 2024 - Available from October 2024

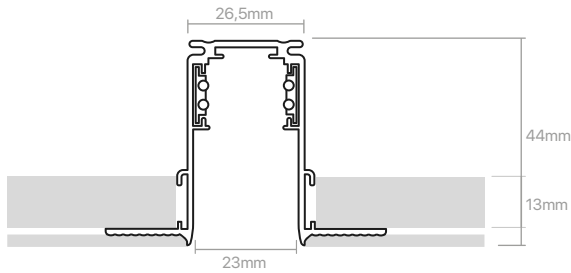

SCHEMA DI COLLEGAMENTO

CONNECTION DIAGRAM

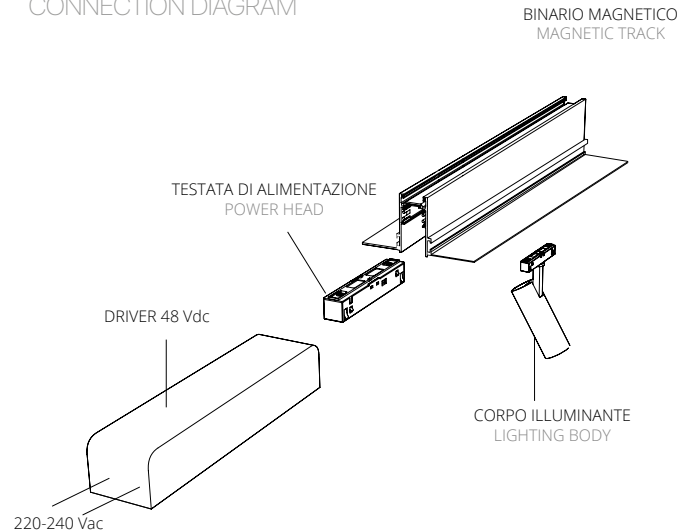

- Profilo estruso in alluminio puro al 99%
- Verniciato a polveri epossidiche
- Elettrificato con 4 conduttori in rame da 2mm² - max 15A
- Versione per montaggio ad incasso a scomparsa
- Il binario può essere tagliato sul posto di lavoro nelle dimensioni desiderate

- 99% pure aluminum extruded profile
- Painted with epoxy powders
- Electrified with 4 conductors, made of 2mm² copper max 15A
- Trimless recessed mounting version
- The track can be cut to length at site

MG245/NE/1MT - € 75,00

Binario magnetico 1mt nero
Magnetic track 1mt black

MG245/BI/1MT - € 75,00

Binario magnetico 1mt bianco
Magnetic track 1mt white

MG245/NE - € 150,00

Binario magnetico 2mt nero
Magnetic track 2mt black

MG245/BI - € 150,00

Binario magnetico 2mt bianco
Magnetic track 2mt white

MG245/NE/3MT - € 235,00

Binario magnetico 3mt nero
Magnetic track 3mt black

MG245/BI/3MT - € 235,00

Binario magnetico 3mt bianco
Magnetic track 3mt white

Tappi e Cover da cantiere inclusi.

Caps and Black covers included.

Accessori

Accessories



MGAL/NE - € 22,50
Modulo alimentazione 4p magnetico nero
Black magnetic 4p power supply module



MGCOF540/NE - € 30,50
Giunzione flessibile nera per binario magnetico
Black flexible joint for magnetic track



MGCO245/NE2/P - € 58,50
Connettore Soffitto-Parete nero
Black Ceiling-Wall Connector



MGALC/NE - € 22,50
Giunzione lineare elettrica nera
Black electrical linear joint



MGCO245/NE2 - € 58,50
Giunzione angolare meccanica 90° nera
Black 90° mechanical corner joint

MGCO245/BI2 - € 58,50
Giunzione angolare meccanica 90° bianca
White 90° mechanical corner joint



TR48100/MG/NE - € 150,00
Alimentatore a scomparsa 48V 100W nero
48V 100W Black retractable power supply

TR48100/MG/BI - € 150,00
Alimentatore a scomparsa 48V 100W bianco
48V 100W White retractable power supply

TR48200/MG/NE - € 180,00
Alimentatore a scomparsa 48V 200W nero
48V 200W Black retractable power supply

TR48200/MG/BI - € 180,00
Alimentatore a scomparsa 48V 200W bianco
48V 200W White retractable power supply

Flex LED series





Novità Serie Flex Custom

Nuove Strip LED per la famiglia della serie Flex, progettate per portare l'illuminazione ad un nuovo livello.

Flex LED 220V: Illuminazione potente, senza confini.

La nuova FLEX con strip LED 220V è il nostro gioiello di efficienza e praticità. Grazie alla sua capacità di illuminare fino a 20 metri con un unico punto di alimentazione diretta a 220V, è la soluzione ideale per grandi ambienti che richiedono una distribuzione luminosa omogenea e continua.

Flex LED 1010 RGB: Esprime la tua creatività con ogni colore.

Per chi cerca un'illuminazione colorata in spazi ridotti, la nuova FLEX 1010 RGB è la scelta perfetta. Con il suo design compatto, è in grado di adattarsi a qualsiasi ambiente, offrendo la possibilità di creare atmosfere suggestive con qualsiasi colore desiderato. È l'ideale per illuminare interni, dettagli architettonici, mobili e molto altro, trasformando anche i luoghi più piccoli con un tocco di colore dinamico.

Flex LED RGB Dati: Illuminazione in movimento.

Porta il movimento nella tua illuminazione con la nostra FLEX LED RGB Dati. Questa Flex permette effetti di luce dinamici e scenografici. Perfetta per installazioni artistiche, eventi speciali e ambienti che richiedono un'illuminazione interattiva e coinvolgente.

New Flex Custom Series

New LED Strips for the Flex series family, designed to take lighting to a new level.

Flex LED 220V: Powerful lighting, without boundaries.

The new FLEX with 220V LED strip is our jewel of efficiency and practicality. Thanks to its ability to illuminate up to 20 meters with a single direct 220V power supply point, it is the ideal solution for large locations that require homogeneous and continuous light distribution.

Flex LED 1010 RGB: Express your creativity with every color.

For those looking for colored lighting in small spaces, the new FLEX 1010 RGB is the perfect choice. With its compact design, it is able to adapt to any space, offering the possibility of creating suggestive atmospheres with any desired color. It is ideal for illuminating interiors, architectural details, furniture and much more, transforming even the smallest places with a touch of dynamic colour.

Flex LED RGB Data: Lighting on the move.

Bring movement into your lighting with our FLEX LED RGB Data. This Flex allows for dynamic and scenographic lighting effects. Perfect for art installations, special events and locations that require interactive and engaging lighting.



Strip LED Flex 1010

Flex 1010 LED strip

Disponibile subito - Now available

CUSTOM



DOPPIA INTESAIONE - 25 €
Consigliato per lunghezze superiori a 5 mt

DOUBLE HEADING - 25 €
Recommended for lengths over 5 m

La strip LED FLEX CUSTOM ti permette di scegliere la lunghezza più adatta alle tue esigenze, ricevendo direttamente il prodotto finito pronto per l'installazione.

Lunghezza massima 10 mt. IP 65. Autodissipante.

The custom flex LED strip allows you to choose the length that better suits your needs, directly receiving the finished product ready for installation.

Maximum length 10 meters. IP 65. Self dissipating.

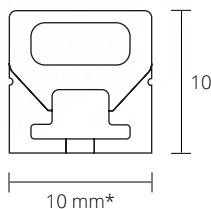
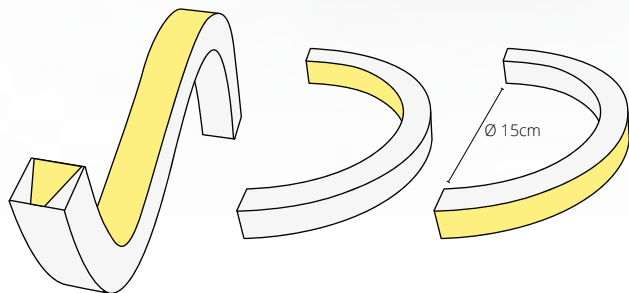

FL1010

Tubo vuoto flex 10x10mm in silicone.
Dimensioni con tappi 12x12mm.

Empty flex tube 10x10mm silicone.
Size with caps 12x12mm.

1. Scegli la strip compatibile

1. Choose the compatible strip

Codice Code	W/MT W/MT	Listino Price
NEW SL125RGB	14,4W/MT	€ 60,00/MT

Altre Strip compatibili vedi pag. 153 del Catalogo Operativo
For more compatible strips, check page 153 of the Operative Catalog.

2. Tipologia di fissaggio

2. Type of fixing

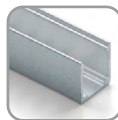

Profilo FL220CL2 - € 22,50

Profilo in alluminio 2mt
Aluminum profile 2mt



FL220CL - € 1,20

Staffa di fissaggio
Mounting plate

Accessori

Accessories



FL1010TA - € 1,00

Tappo chiuso
Closed end cap



FL1010TA/1 - € 1,00

Tappo forato
End cap with hole



Strip LED Flex 916

Flex 916 LED strip

Disponibile subito - Now available

CUSTOM



DOPPIA INTESTAZIONE - 25 €
Consigliato per lunghezze superiori a 5 mt
(ad eccezione della serie 48V e 220V)
DOUBLE HEADING - 25 €
Recommended for lengths over 5 m
(except 48V and 220V series)

La strip LED FLEX CUSTOM ti permette di scegliere la tipologia di strip con le caratteristiche più adatte alle tue esigenze, ricevendo direttamente il prodotto finito pronto per l'installazione.
Lunghezza massima 20 mt. IP 65.
Prodotto autodissipante.

The CUSTOM FLEX LED STRIP allows you to choose the type of strip with the features that better suits your needs, directly receiving the final product ready for installation.
Maximum length 20 meters. IP 65.
The fixture can dissipate the heat by itself.

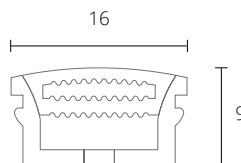
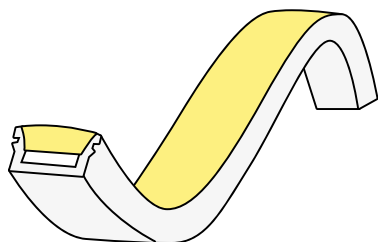

FL916
Tubo vuoto flex 9x16 mm silicone
Empty flex tube 9x16 mm silicone

1. Scegli la strip compatibile

1. Choose the compatible strip

	Codice Code	W/MT W/MT	Listino Price
NEW	SLP220	16W/MT	€ 65,00/MT
NEW	RGB.D	24W/MT	€ 70,00/MT

Altre Strip compatibili vedi pag. 154 del Catalogo Operativo
For more compatible strips, check page 154 of the Operative Catalog.

2. Tipologia di fissaggio

2. Type of fixing

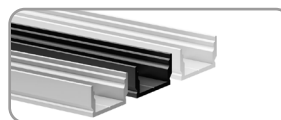

Profilo PR115
Profilo in alluminio 2mt/3mt
Aluminum profile 2mt/3mt

Per dettagli vedere pag. 168
For details see page. 168



Staffa EN916 - € 1,30
Staffa fissaggio
Metal holder

Accessori Accessories



FL916TA - € 1,00
Tappo a filo chiuso
Levelled closed end cap



FL916TA/1 - € 1,00
Tappo a filo forato
Levelled end cap with hole

Strip LED Flex 1616

Flex 1616 LED strip

Disponibile subito - Now available

CUSTOM



DOPPIA INTESAZIONE - 25 €
Consigliato per lunghezze superiori a 5 mt
(ad eccezione della serie 48V e 220V)
DOUBLE HEADING - 25 €
Recommended for lengths over 5 m
(except 48V and 220V series)

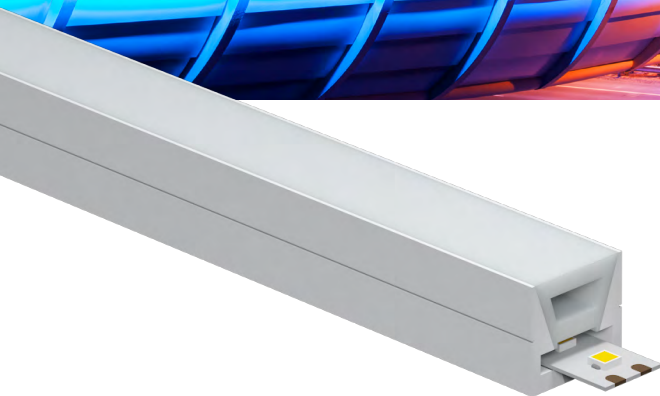

La strip LED FLEX CUSTOM ti permette di scegliere la tipologia di strip con le caratteristiche più adatte alle tue esigenze, ricevendo direttamente il prodotto finito pronto per l'installazione.
Lunghezza massima 20 mt. IP 65.
Prodotto autodissipante.

The CUSTOM FLEX LED STRIP allows you to choose the type of strip with the features that better suits your needs, directly receiving the final product ready for installation.
Maximum length 20 meters. IP 65.
The fixture can dissipate the heat by itself.

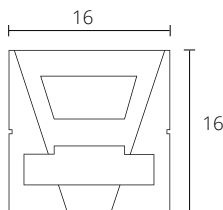
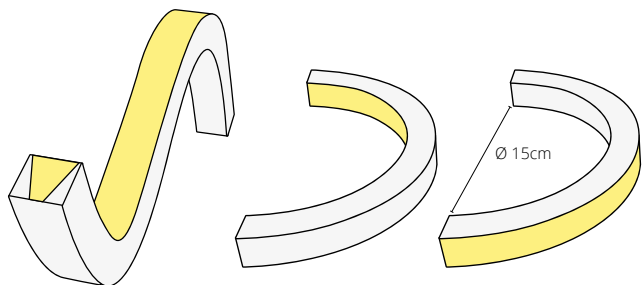

FL1616
Tubo vuoto flex 16x16 mm silicone
(18x18 mm con tappi)
Empty flex tube 16x16 mm silicone
(18x18 mm with end caps)

1. Scegli la strip compatibile

1. Choose the compatible strip

Codice Code	W/MT W/MT	Listino Price
NEW SLP220	16W/MT	€ 65,00/MT
NEW RGB.D	24W/MT	€ 70,00/MT

Altre Strip compatibili vedi pag. 155 del Catalogo Operativo
For more compatible strips, check page 155 of the Operative Catalog.

2. Tipologia di fissaggio

2. Type of fixing



Profilo PR120
Profilo in alluminio 2mt/3mt
Aluminum profile 2mt/3mt



Staffa FL1616CL - € 1,30
Staffa fissaggio
Metal holder

Per dettagli vedere pag. 172
For details see page. 172



Profilo PR211 - € 35,50
Profilo in alluminio 2mt
Aluminum profile 2mt

Profilo PR211/BI - € 47,00
Profilo Bianco 2mt
White profile 2mt

Accessori

Accessories



FL1616TA - € 1,00
Tappo chiuso
Closed end cap



FL1616TA/1 - € 1,00
Tappo forato
End cap with hole



FL1616TA/1L - € 1,00
Tappo con foro laterale
End cap with side hole

*Su richiesta sono disponibili i tappi a filo.
Tappo a filo chiuso FL1616TF
Tappo a filo forato FL1616TF/1
*Levelled end caps available on request.
Levelled closed end cap FL1616TF
Levelled end cap with hole FL1616TF/1

Strip LED Flex 612

Flex 612 LED strip

Disponibile subito - Now available

CUSTOM



DOPPIA INTESAZIONE - 25 €
Consigliato per lunghezze superiori a 5 mt

DOUBLE HEADING - 25 €
Recommended for lengths over 5 mt

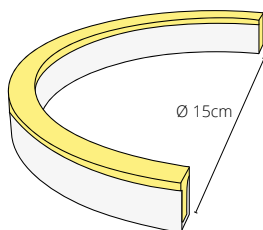
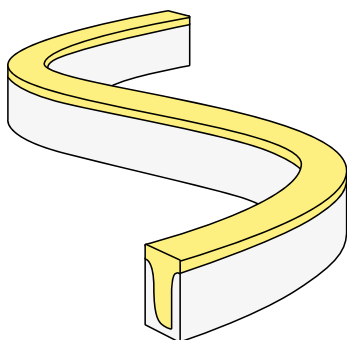

La strip LED FLEX CUSTOM ti permette di scegliere la tipologia di strip con le caratteristiche più adatte alle tue esigenze, ricevendo direttamente il prodotto finito pronto per l'installazione.
Lunghezza massima 10 mt con doppia alimentazione. IP 65.
Prodotto autodissipante.

The CUSTOM FLEX LED STRIP allows you to choose the type of strip with the features that better suits your needs, directly receiving the final product ready for installation.
Maximum length 10 meters with double power supply. IP 65.
The fixture can dissipate the heat by itself.

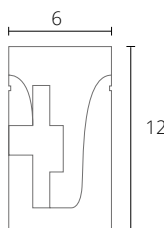

FL612

Tubo vuoto flex 6x12 mm silicone
(8x14 mm con tappi)
Empty flex tube 6x12 mm silicone
(8x14 mm with end caps)

1. Scegli la strip compatibile

1. Choose the compatible strip

Codice Code	W/MT W/MT	Listino Price
NEW SL125RGB	14,4W/MT	€ 60,00/MT

Altre Strip compatibili vedi pag. 156 del Catalogo Operativo
For more compatible strips, check page 156 of the Operative Catalog.

2. Tipologia di fissaggio

2. Type of fixing



Staffa FL612CL - € 1,00
Staffa fissaggio
Metal holder

Accessori Accessories



FL612TA - € 1,00
Tappo chiuso
Closed end cap



FL612TA/1 - € 1,00
Tappo forato
End cap with hole

Strip LED Flex 1018

Flex 1018 LED strip

Disponibile subito - Now available

CUSTOM



DOPPIA INTESAZIONE - 25 €

Consigliato per lunghezze superiori a 5 mt (ad eccezione della serie 48V e 220V)

DOUBLE HEADING - 25 €

Recommended for lengths over 5 m (except 48V and 220V series)

La strip LED FLEX CUSTOM ti permette di scegliere la tipologia di strip con le caratteristiche più adatte alle tue esigenze, ricevendo direttamente il prodotto finito pronto per l'installazione.

Lunghezza massima 20 mt. IP 65.

Prodotto autodissipante.

The CUSTOM FLEX LED STRIP allows you to choose the type of strip with the features that better suits your needs, directly receiving the final product ready for installation.

Maximum length 20 meters. IP 65.

The fixture can dissipate the heat by itself.

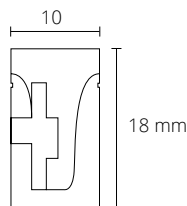
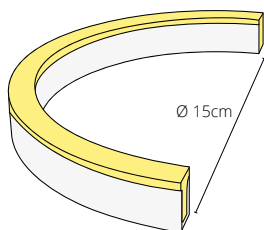
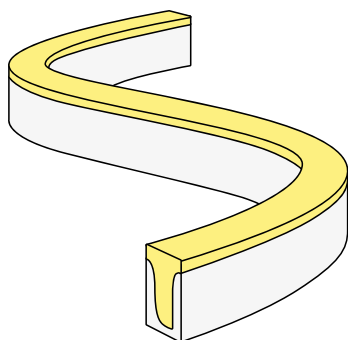
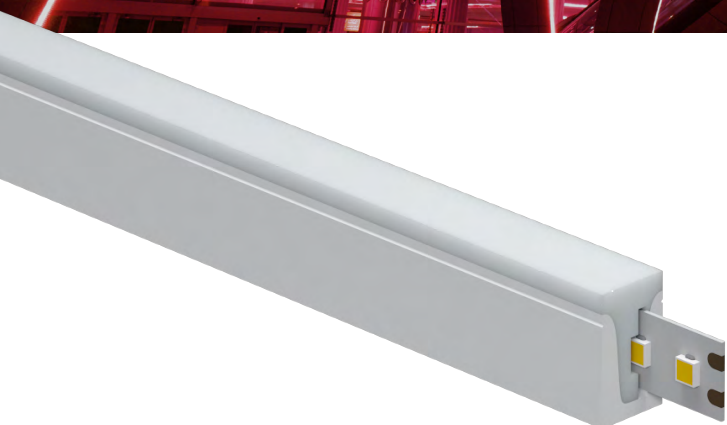

FL1018

Tubo vuoto flex 10x18 mm silicone (12x20 mm con tappi)

Empty flex tube 10x18 mm silicone (12x20 mm with end caps)

1. Scegli la strip compatibile

1. Choose the compatible strip

	Codice Code	W/MT W/MT	Listino Price
NEW	SLP220	16W/MT	€ 65,00/MT
NEW	RGB.D	24W/MT	€ 70,00/MT

Altre Strip compatibili vedi pag. 157 del Catalogo Operativo
For more compatible strips, check page 157 of the Operative Catalog.

2. Tipologia di fissaggio

2. Type of fixing

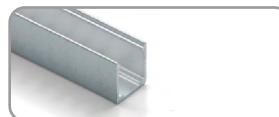

Profilo FL220CL2 - € 22,50
Profilo in alluminio 2mt
Aluminum profile 2mt



Staffa FL220CL - € 1,20
Staffa fissaggio
Metal holder

Accessori Accessories



FL1018TA - € 1,00
Tappo chiuso
Closed end cap



FL1018TA/1 - € 1,00
Tappo forato
End cap with hole



FL1018TA/1L - € 1,00
Tappo con foro laterale
End cap with side hole



FL1018TA/1F - € 1,00
Tappo con foro dal basso
Cap with hole from the bottom

220V series

Dispositivo Anti Flicker per Strip LED 220V.

Che cos'è l'Anti Flicker?

Il dispositivo Anti Flicker è una tecnologia progettata per eliminare l'effetto strobo, comunemente noto come flickering, delle strip LED a 220V. Questo effetto può causare fastidio visivo e affaticamento, soprattutto in ambienti dove le luci sono accese per lunghi periodi di tempo.

Perché è importante?

Comfort Visivo

Grazie a questo dispositivo, le nostre strip LED a 220V garantiscono una luce stabile e continua, senza fastidiosi tremolii. Questo significa un maggiore comfort visivo e l'annullamento dei disturbi negli impianti di videosorveglianza.

Efficienza e Durata

L'eliminazione del flickering non solo migliora la qualità della luce, ma contribuisce anche a prolungare la vita delle strip LED. Un'illuminazione più stabile significa meno stress per i componenti elettronici interni.

Anti Flicker Device for 220V LED Strip.

What is Anti Flicker?

The Anti Flicker device is a technology designed to eliminate the strobe effect, commonly known as flickering, of 220V LED strips. This effect can cause visual discomfort and fatigue, especially in places where the lights are on for a long time.

Why is it important?

Visual Comfort

Thanks to this device, our 220V LED strips guarantee stable and continuous light, without the annoying flickering. This means greater visual comfort and the elimination of disturbances in video surveillance systems.

Efficiency and Durability

The elimination of flickering not only improves the quality of light, but also helps to prolong the life of the LED strips. More stable lighting means less stress on internal electronic components.

SLP220 - Dispositivo Anti Flicker 220V

SLP220 - 220V Anti Flicker Device

Disponibile subito - Now available

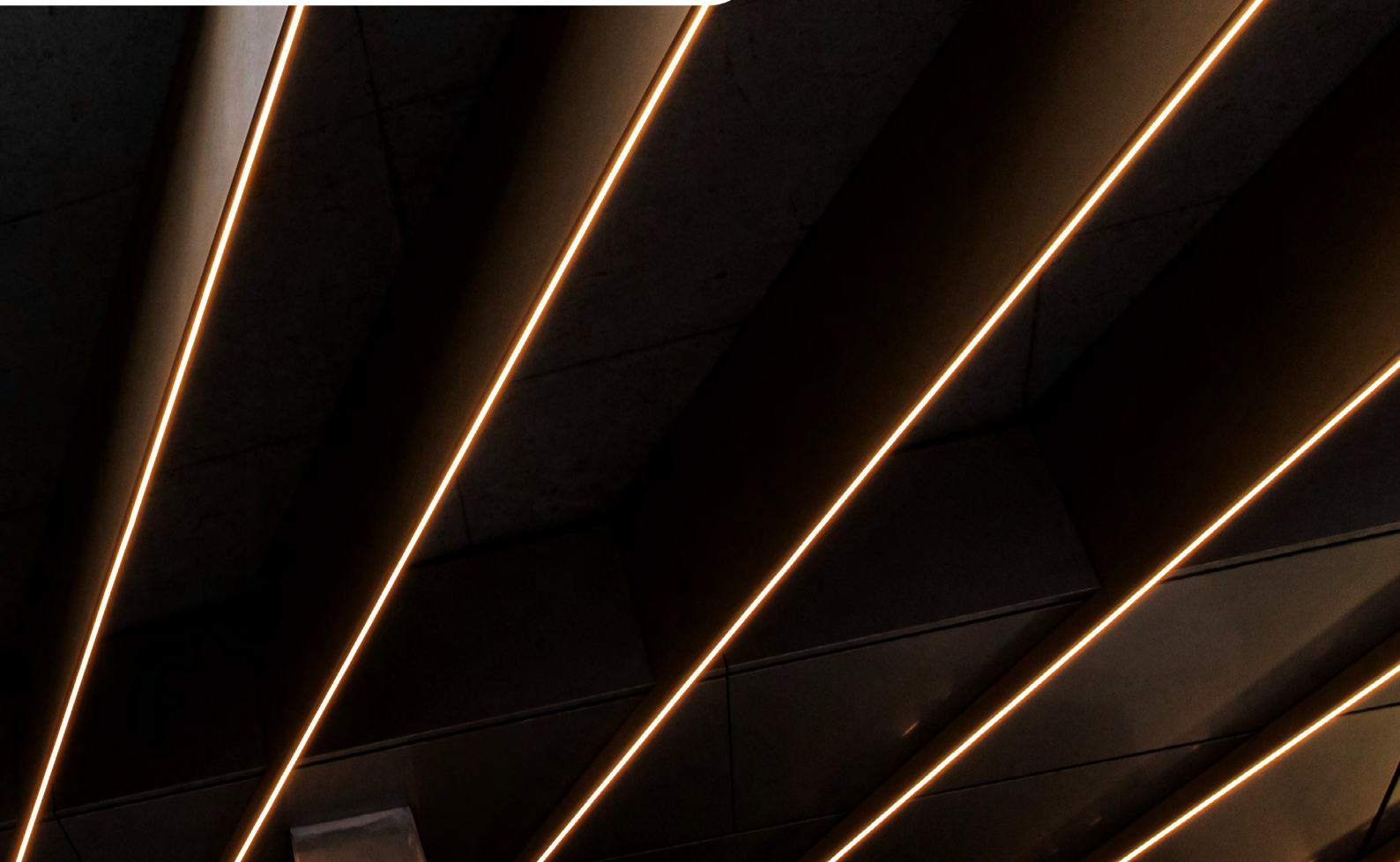

SLP220 - € 80,00

Il dispositivo Anti Flicker per strip LED a 220V è progettato per eliminare l'effetto strobo, questo significa un maggiore comfort visivo e l'annullamento dei disturbi negli impianti di videosorveglianza.

Potenza: 400W
Tensione: 220V
IP20

Our Anti Flicker device for 220V LED strips is designed to eliminate the strobe effect, this means greater visual comfort and the cancellation of disturbances in video surveillance systems.

Power: 400W
Voltage: 220V
IP20

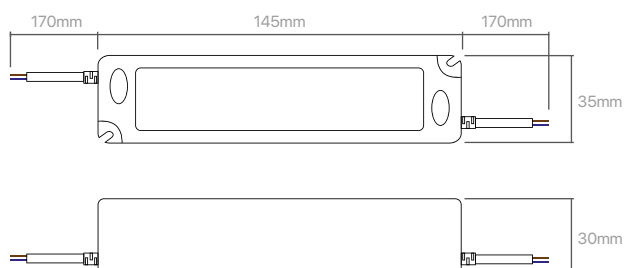

**Annullamento
dei disturbi
negli impianti di
videosorveglianza**

Cancellation of
interferences
in video surveillance
systems



Strip LEDs





Strip LED COB SLC50 IP67

COB LED Strip SLC50 IP67

Disponibile da Agosto 2024 - Available from August 2024



- Strip LED flessibile per illuminazione lineare con LED monocromatico, bobina da 5 metri
- Sezionabile ad intervalli prefissati ogni 5 cm
- Nastro adesivo 3M VHB ad alto potere adesivo anche in ambienti umidi e su profili verniciati a polveri
- La doppia intestazione di cavi con guaina in neoprene permette anche la connessione stagna tramite pressacavo
- L'elevata densità dei LED (576 chip/metro) consente un'illuminazione omogenea su tutte le superfici
- Prodotto adatto all'installazione in ambienti esterni o ad immersione, anche in acqua clorata e salata

- Flexible LED strip for linear lighting with monochromatic LED, 5 meter coil
- Can be sectioned at pre-set intervals every 5 cm
- 3M VHB adhesive tape with high adhesive power even in humid environments and on powder-coated profiles
- The double header of cables with neoprene sheath also allows the waterproof connection via cable gland
- The high density of the LEDs (576 chips/meter) allows homogeneous lighting on all surfaces
- Product suitable for installation in outdoor environments or for immersion, even in chlorinated and salt water

Strip LED COB fino a 10 metri COB LED Strip up to 10 meters

Per la connessione delle Strip LED COB da 10mt si consiglia l'alimentazione da entrambi i lati così da evitare cadute di tensione.

For the connection of the 10 m COB LED Strips, we recommend power supply from both sides to avoid voltage drops.

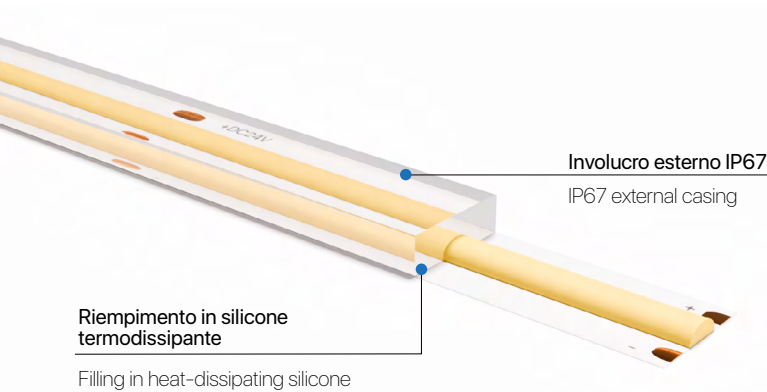

ACCESSORI - ACCESSORIES

EN720 - € 0,80
Tappo di chiusura
End Cap

SILICONE - € 2,50
Tubetto silicone 10ml
10ml silicone tube

EN720/1 - € 0,80
Tappo forato
End Cap with hole

EN68/12 - € 1,00
Staffe per montaggio a parete
Brackets for wall mounting

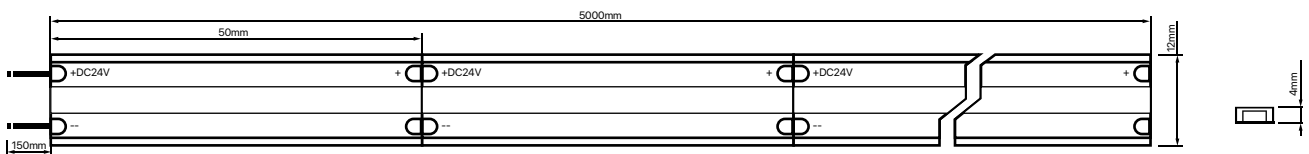

	Codice Code	IP IP	Consumo Power	W/MT W/MT	Temp. Temp.	LED/MT LED/MT	Lumen/MT Lumen/MT	Lumen Lumen	DC DC	Listino Price
5 metri	● SLC50LBC67	67	50W	10W/MT	3000K	576	1480	7400	24V	€ 140,00
	● SLC50LBN67	67	50W	10W/MT	4000K	576	1520	7600	24V	€ 140,00
	● SLC50LBI67	67	50W	10W/MT	6000K	576	1560	7800	24V	€ 140,00
10 metri	● SLC50LBC67/10	67	100W	10W/MT	3000K	576	1480	14800	24V	€ 280,00
	● SLC50LBN67/10	67	100W	10W/MT	4000K	576	1520	15200	24V	€ 280,00
	● SLC50LBI67/10	67	100W	10W/MT	6000K	576	1560	15600	24V	€ 280,00



Strip LED COB SLC30 ES IP67

COB LED Strip SLC30 ES IP67

Disponibile da Agosto 2024 - Available from August 2024



- Strip LED flessibile per illuminazione lineare con LED monocromatico, bobina da 5 metri
 - Sezionabile ad interassi prefissati ogni 5 cm
 - Nastro adesivo 3M VHB ad alto potere adesivo anche in ambienti umidi e su profili verniciati a polveri
 - La doppia intestazione di cavi con guaina in neoprene permette anche la connessione stagna tramite pressacavo
 - L'elevata densità dei LED (480 chip/metro) consente un'illuminazione omogenea su tutte le superfici
 - Prodotto adatto all'installazione in ambienti esterni o ad immersione, anche in acqua clorata e salata
- Flexible LED strip for linear lighting with monochromatic LED, 5 meter coil
 - Can be sectioned at pre-set intervals every 5 cm
 - 3M VHB adhesive tape with high adhesive power even in humid environments and on powder-coated profiles
 - The double header of cables with neoprene sheath also allows the waterproof connection via cable gland
 - The high density of the LEDs (480 chips/meter) allows homogeneous lighting on all surfaces
 - Product suitable for installation in outdoor environments or for immersion, even in chlorinated and salt water
- La SLC30 Energy Saving differisce dalla versione standard per il numero di Lumen e il consumo di energia ridotto, mantenendo l'uniformità luminosa.
 - The SLC30 Energy Saving differs from the standard version in terms of the number of lumens and reduced energy consumption, maintaining luminous uniformity.

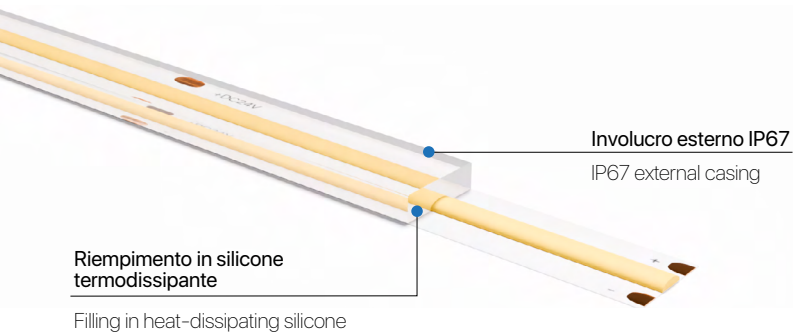

Strip LED COB fino a 10 metri

COB LED Strip up to 10 meters

Per la connessione delle Strip LED COB da 10mt si consiglia l'alimentazione da entrambi i lati così da evitare cadute di tensione.

For the connection of the 10 m COB LED Strips, we recommend power supply from both sides to avoid voltage drops.

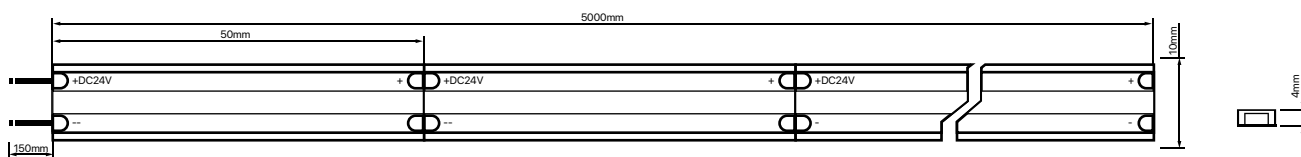

	Codice Code	IP IP	Consumo Power	W/MT W/MT	Temp. Temp.	LED/MT LED/MT	Lumen/MT Lumen/MT	Lumen Lumen	DC DC	Listino Price
5 metri	SLC30LBH67	67	30W	6W/MT	2700K	480	936	4680	24V	€ 115,00
	SLC30LBC67	67	30W	6W/MT	3000K	480	962	4810	24V	€ 115,00
	SLC30LBN67	67	30W	6W/MT	4000K	480	988	4940	24V	€ 115,00
	SLC30LBI67	67	30W	6W/MT	6000K	480	1014	5070	24V	€ 115,00
10 metri	SLC30LBH67/10	67	60W	6W/MT	2700K	480	936	9360	24V	€ 230,00
	SLC30LBC67/10	67	60W	6W/MT	3000K	480	962	9620	24V	€ 230,00
	SLC30LBN67/10	67	60W	6W/MT	4000K	480	988	9880	24V	€ 230,00
	SLC30LBI67/10	67	60W	6W/MT	6000K	480	1014	10140	24V	€ 230,00



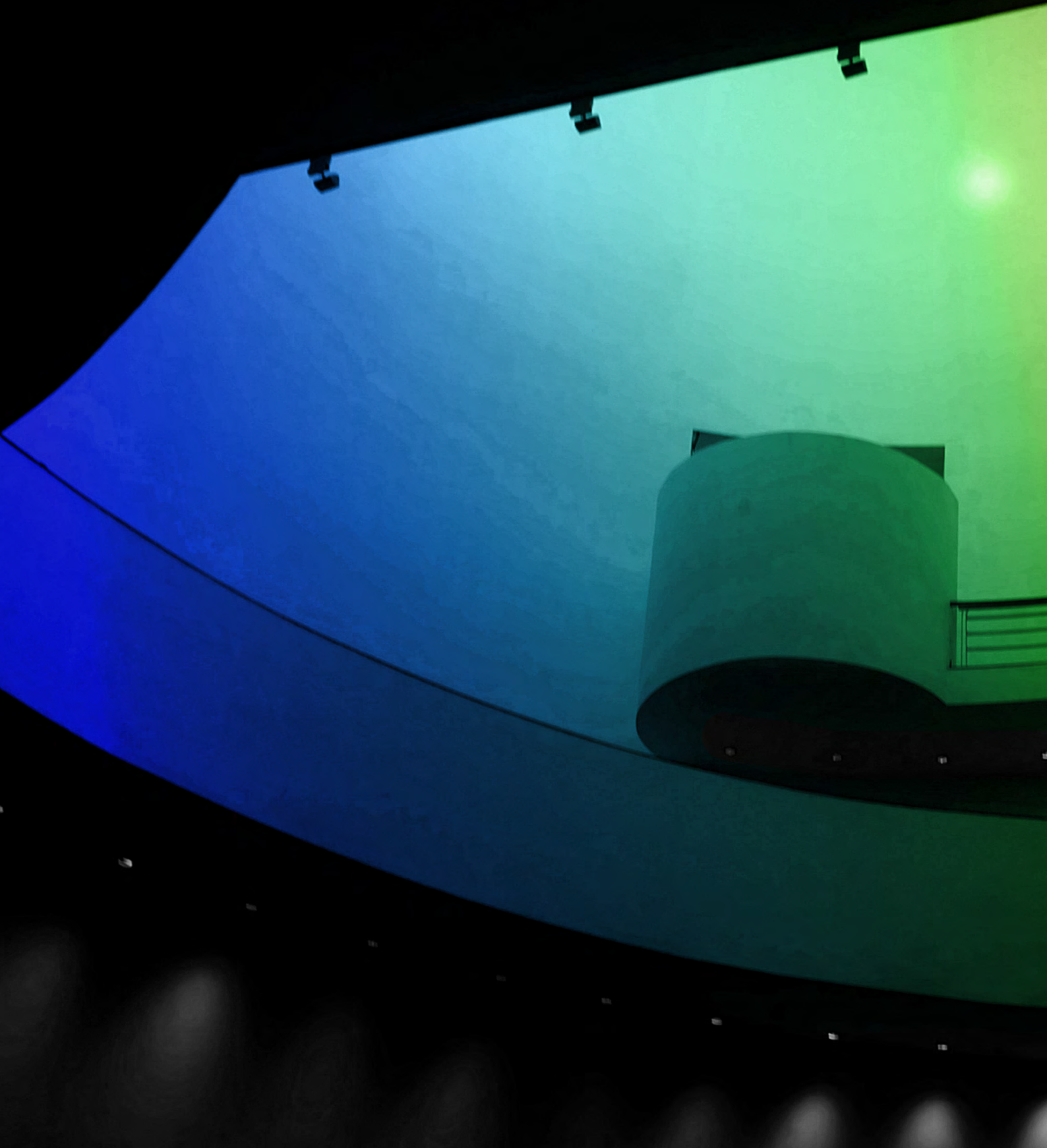

STRIP LED RGB IP20 5mm

RGB LED STRIP IP20 5mm

Strip LED RGB IP20 - 5mm - Chip 2835

RGB LED Strip

Disponibile subito - Now available



- Strip LED flessibile per illuminazione lineare con LED RGB multicolori, bobina da 5 metri
- Sezionabile ad interassi prefissati ogni 5 cm
- La pista flessibile miniaturizzata a soli 5 mm permette l'installazione anche in spazi molto piccoli
- Nastro adesivo 3M sul retro
- La doppia intestazione di cavi permette una connessione in serie più rapida

- Flexible LED strip for linear lighting with multichromatic RGB LEDs, 5 meter coil
- Can be sectioned at pre-set intervals every 5 cm
- The miniaturized flexible track of just 5 mm allows installation even in very small spaces
- 3M adhesive tape on the back
- The double cable header allows for faster series connection



Controller ed Accessori

Controller and Accessories

pag. 231 Catalogo Operativo 2024

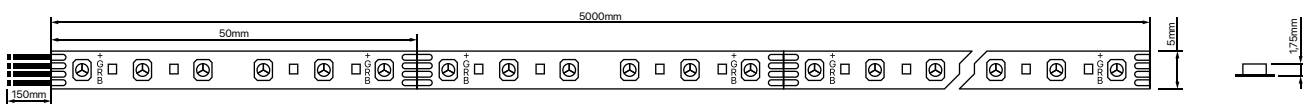

Codice Code	IP IP	Consumo Power	W/MT W/MT	Temp. Temp.	LED/MT LED/MT	Lumen/MT Lumen/MT	Lumen Lumen	DC DC	Listino Price
●●● SL125RGB20	20	72W	14,4W/MT	RGB	120	1280	6400	24V	€ 95,00



STRIP LED RGB Dati IP20

RGB LED STRIP Data IP20

Strip LED RGB Dati IP20 - Chip 5050

RGB LED Strip Data

Disponibile da Agosto 2024 - Available from August 2024

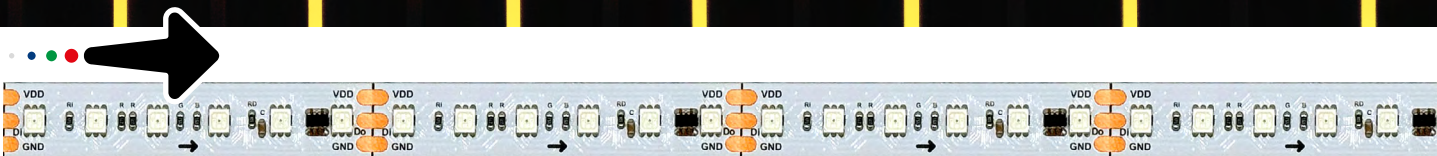

Strip flessibile per illuminazione lineare, utilizza la tecnologia BUS per poter controllare singolarmente i settori che compongono la strip led. I micro processori presenti sulla strip consentono un controllo del colore di ogni singolo tratto con la possibilità di creare giochi di luce unici.

The flexible strip for linear illumination uses the BUS technology to control each led strip sector. The micro processors on the strip control the color of every part and can also create unique games of light.

- Strip LED flessibile per illuminazione lineare con LED RGB multicolorato, bobina da 5 metri
- Sezionabile ad intervalli prefissati ogni 4,5 cm
- Nastro adesivo 3M sul retro
- La doppia intestazione di cavi permette una connessione in serie più rapida

- Flexible LED strip for linear lighting with multichromatic RGB LEDs, 5 meter coil
- Can be sectioned at pre-set intervals every 4,5 cm
- 3M adhesive tape on the back
- The double cable header allows for faster series connection



Controller ed Accessori
Controller and Accessories
pag. 231

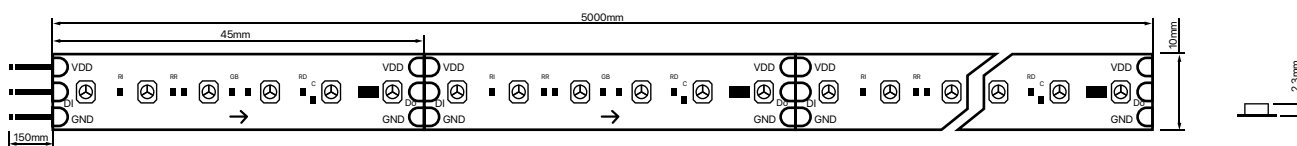

Codice Code	IP IP	Consumo Power	W/MT W/MT	Temp. Temp.	LED/MT LED/MT	Lumen/MT Lumen/MT	Lumen Lumen	DC DC	Listino Price
RGB SL120RGBD20	20	120W	24W/MT	RGB	120	1280	6400	24V	€ 120,00

120° LED'S ANGLE
IP20 INTERNAL USE
RoHS CERTIFICATE
CE CERTIFICATE
DC 24 LOW VOLTAGE SAFETY
2 year WARRANTY

Profili in alluminio

Aluminum Profiles





Profili ad Incasso a Scomparsa Curvabili

Bendable Trimless Recessed Profiles

Abbiamo introdotto due nuovi profili per chi desidera creare illuminazioni continue e flessibili.

Le caratteristiche principali di questi due prodotti sono la **Curvabilità** e l'**installazione a scomparsa**, così da integrarsi perfettamente nelle superfici, garantendo un effetto pulito e moderno.

We have introduced two new profiles for those who want to create continuous and flexible lighting.

The main characteristics of these two products are **bendability** and **recessed installation**, so as to integrate perfectly into the surfaces, guaranteeing a clean and modern effect.



PR224/FL - Profilo ad Incasso a Scomparsa Curvabile

PR224/FL - Bendable Trimless Recessed Profile

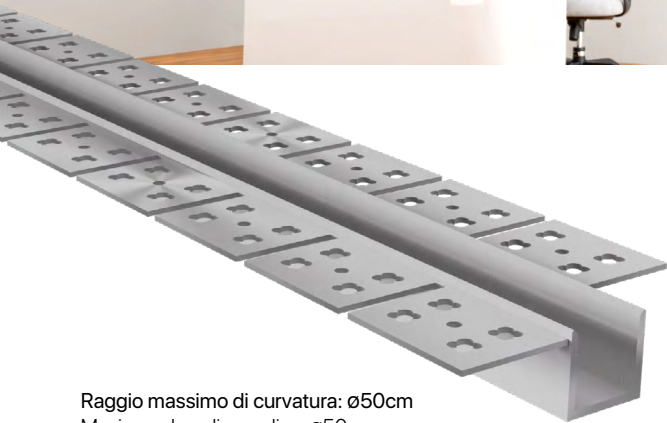

Raggio massimo di curvatura: $\varnothing 50\text{cm}$
Maximum bending radius: $\varnothing 50\text{cm}$

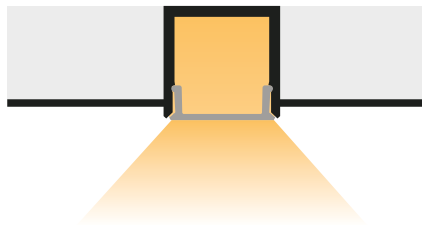
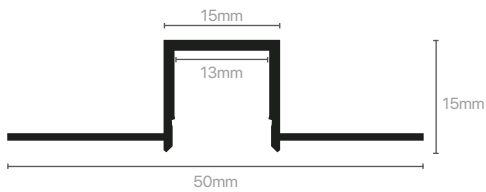

Accessori

Accessories



COVER SU MISURA

PR924/FL - € 6,50/mt
Schermo in silicone opaco
White silicone cover



EN224 - € 2,30
Tappo grigio
Grey end cap

Codice Code	Lunghezza Length	Colore Color	Listino Price
• PR224/FL	2MT	Silver	€ 55,00



Dissipazione fino a 20w/mt
Power dissipation up to 20w/mt



Elimina l'effetto puntinato
Eliminates the dotted effect



Strip LED compatibile

Compatible LED Strips

Codice Code	W/MT W/MT	Listino Price
SL120	16W/MT	€ 95,00
SL120 ES	8W/MT	€ 85,00
WL60	12W/MT	€ 95,00

PR225/FL - Profilo ad Incasso a Scomparsa Curvabile

PR225/FL - Bendable Trimless Recessed Profile

Disponibile da Ottobre 2024 - Available from October 2024

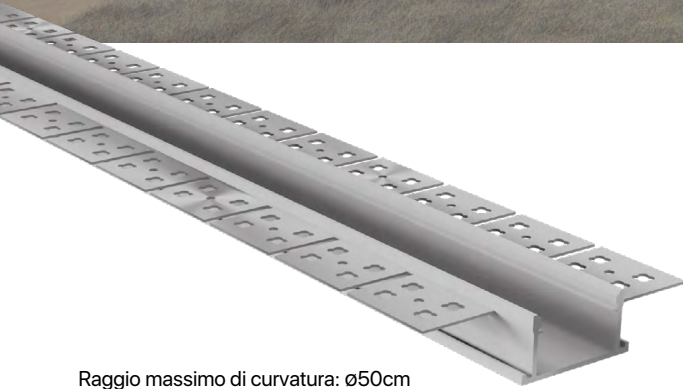

Raggio massimo di curvatura: $\varnothing 50\text{cm}$
Maximum bending radius: $\varnothing 50\text{cm}$

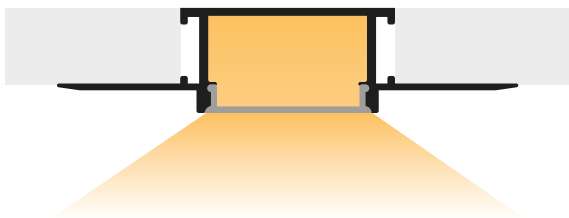
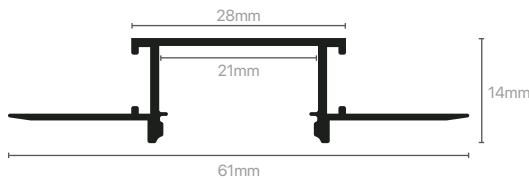

Codice Code	Lunghezza Length	Colore Color	Listino Price
• PR225/FL	2MT	Silver	€ 60,00

Dissipazione fino a 25w/mt
Power dissipation up to 25w/mt

Elimina l'effetto puntinato
Eliminates the dotted effect



Strip LED compatibile

Compatible LED Strips

Codice Code	W/MT W/MT	Listino Price
SL120	16W/MT	€ 95,00
SL120 ES	8W/MT	€ 85,00
WL60	12W/MT	€ 95,00

Accessori

Accessories



COVER SU MISURA

PR925/FL - € 7,00/mt
Schermo in silicone opaco
White silicone cover



EN225 - € 2,30
Tappo grigio
Grey end cap



PR211 - Profilo ad Incasso

PR211 - Recessed Profile

Disponibile subito - Now available

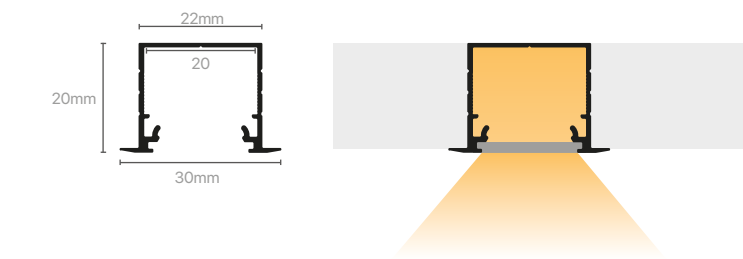

Codice Code	Lunghezza Length	Colore Color	Listino Price
● PR211	2MT	Silver	€ 35,00
● PR211/BI	2MT	Bianco	€ 47,00

Dissipazione fino a 30w/mt
Power dissipation up to 30w/mt

Elimina l'effetto puntinato
Eliminates the dotted effect



Possibilità di
installazione della
Flex FL1616

Accessori Accessories



PR901 - € 20,00
Schermo trasparente 2mt
Transparent cover 2mt
PR901/3 - € 30,00
3mt



PR911 - € 22,00
Schermo opaco 2mt
White cover 2mt
PR911/3 - € 33,00
3mt
PR911/10 - € 110,00
10mt



PR911/NE - € 23,50
Schermo nero 2mt
Black cover 2mt



EN211/1 - € 1,50
Tappo grigio forato
Grey end cap with hole



EN211/1/BI - € 1,50
Tappo bianco forato
White end cap with hole



EN011 - € 1,70
Staffa
Bracket



ENX211 - € 14,00
Staffa per cartongesso
Plasterboard bracket



PR270 - Profilo ad Incasso a Scomparsa

PR270 - Trimless Recessed Profile

Disponibile da Luglio 2024 - Available from July 2024



Codice Code	Lunghezza Length	Colore Color	Listino Price
● PR270/3	3MT	Silver	€ 69,00
● PR270/3BI	3MT	Bianco	€ 95,00

 Dissipazione fino a 30w/mt
Power dissipation up to 30w/mt

 Elimina l'effetto puntinato
Eliminates the dotted effect

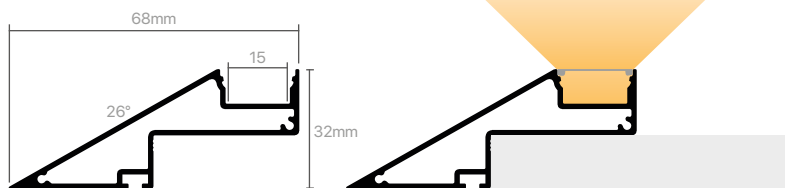

Accessori Accessories



PR901 - € 20,00
Schermo trasparente 2mt
Transparent cover 2mt
PR901/3 - € 30,00
3mt



PR911 - € 22,00
Schermo opaco 2mt
White cover 2mt
PR911/3 - € 33,00
3mt
PR911/10 - € 110,00
10mt



CO230X - € 7,00
Connettore Lineare
Linear connector



PR336 - Profilo Angolare

PR336 - Angular Profile

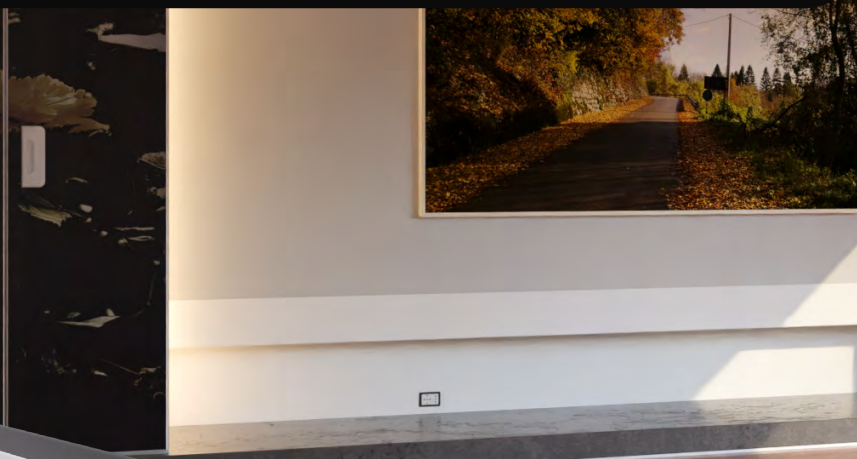

Codice Code	Lunghezza Length	Colore Color	Listino Price
● PR336/3NE	3MT	Nero	€ 296,00
● PR336/3BI	3MT	Bianco	€ 296,00

 Dissipazione fino a 30w/mt
Power dissipation up to 30w/mt

 Elimina l'effetto puntinato
Eliminates the dotted effect

La parte posteriore del profilo è sempre color Silver.
Mentre la parte frontale è in colorazione Bianca o Nera.

The back of the profile it is always Silver in color.
While the front part it is available in White or Black.

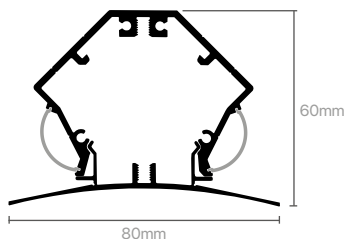

Possibilità di installazione
Trasformatore Slim Classe II.

Possibility of installation
Slim Class II power supply.

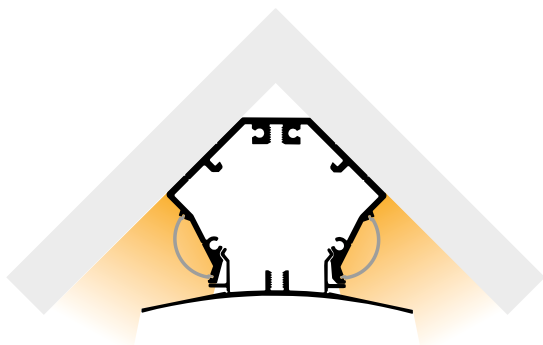

Accessori Accessories



PR936/3 - € 22,00
Schermo curvo opale 3mt
White curved cover 3mt



EN336/BI - € 5,60
Tappo bianco
White cap



EN336/NE - € 5,60
Tappo nero
Black cap



PR620 - Profilo Angolare a Scomparsa

PR620 - Trimless Angular Profile

Disponibile subito - Now available

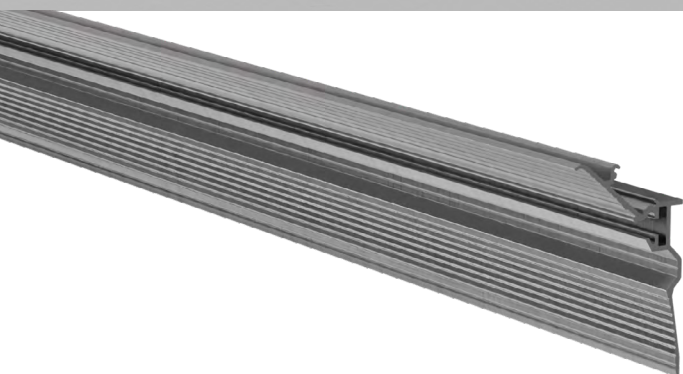
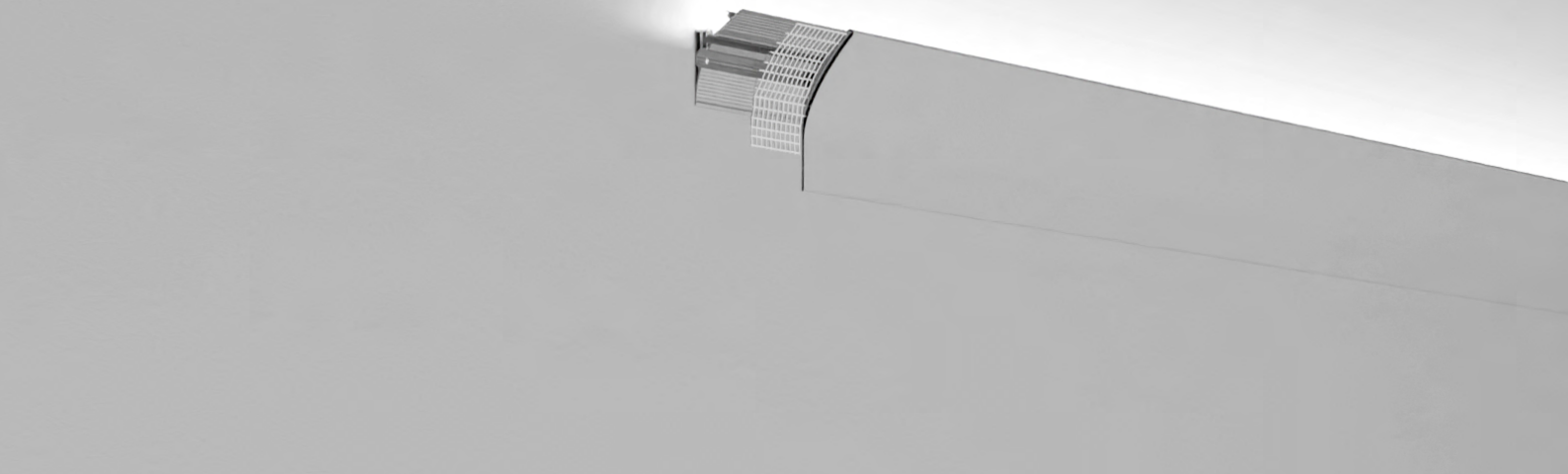

Codice Code	Lunghezza Length	Colore Color	Listino Price
• PR620/3	3MT	Silver	€ 70,00

 Dissipazione fino a 30w/mt
Power dissipation up to 30w/mt

 Elimina l'effetto puntinato
Eliminates the dotted effect

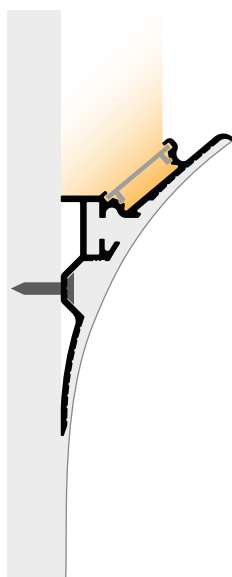
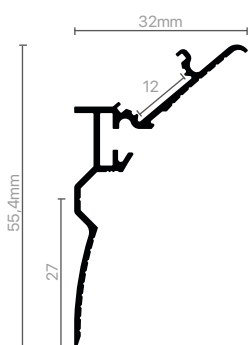

Accessori Accessories



EN620 - € 2,00
Tappo grigio
Gray cap



PR910 - € 10,50
Schermo opaco 2mt
White cover 2mt
PR910/3 - € 17,00
3mt
PR910/10 - € 55,00
10mt



Profili in Cartongesso

Plasterboard Profiles



La nostra nuova linea di cartongessi con profili LED integrati ridefinisce gli standard estetici e funzionali degli spazi abitativi e commerciali.

Questa gamma combina la semplicità d'uso del cartongesso con l'eleganza moderna dell'illuminazione a LED, offrendo soluzioni personalizzabili per l'interior design.

Our new line of plasterboards with integrated LED profiles redefines the aesthetic and functional standards of living and commercial spaces.

This range combines the ease of use of plasterboard with the modern elegance of LED lighting, offering customizable solutions for interior design.

PG270 - Profilo incassato in Cartongesso
 PG270 - Profile embedded in plasterboard

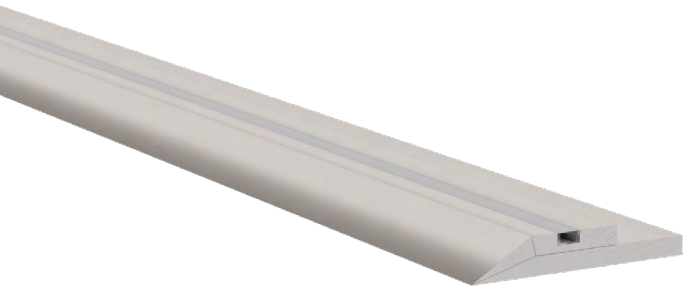

Codice Code	Lunghezza Length	Colore Color	Listino Price
PG270	2MT	Cartongesso	€ 100,00

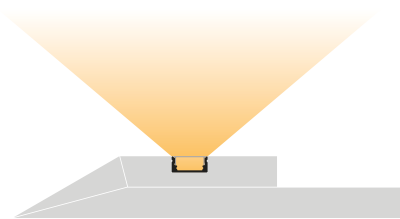
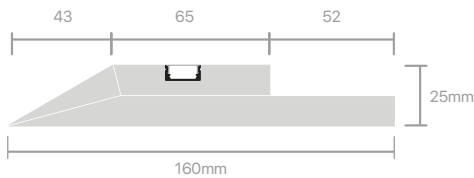

Accessori
 Accessories



EN110 - € 1,00
 Tappo chiuso
 Closed end cap



EN110/1 - € 1,00
 Tappo forato
 End cap with hole

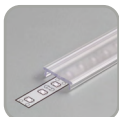

PR990 - € 9,00
 Schermo trasparente 2mt
 Transparent cover 2mt



PR991 - € 10,50
 Schermo opaco 2mt
 White cover 2mt
PR991/10 - € 52,50
 Schermo opaco 10mt
 White cover 10mt

PG165 - Profilo incassato in Cartongesso

PG165 - Profile embedded in plasterboard

Disponibile subito - Now available

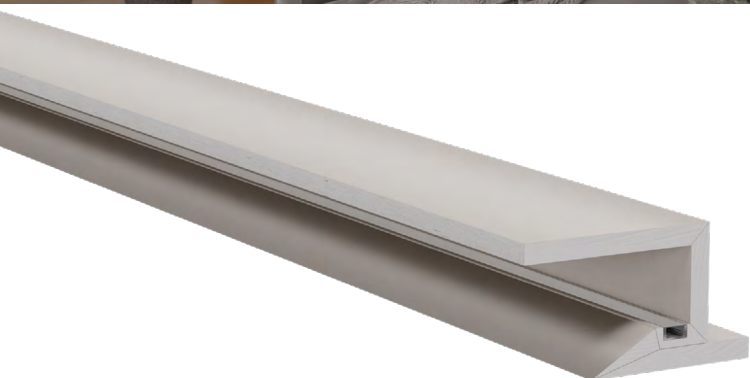
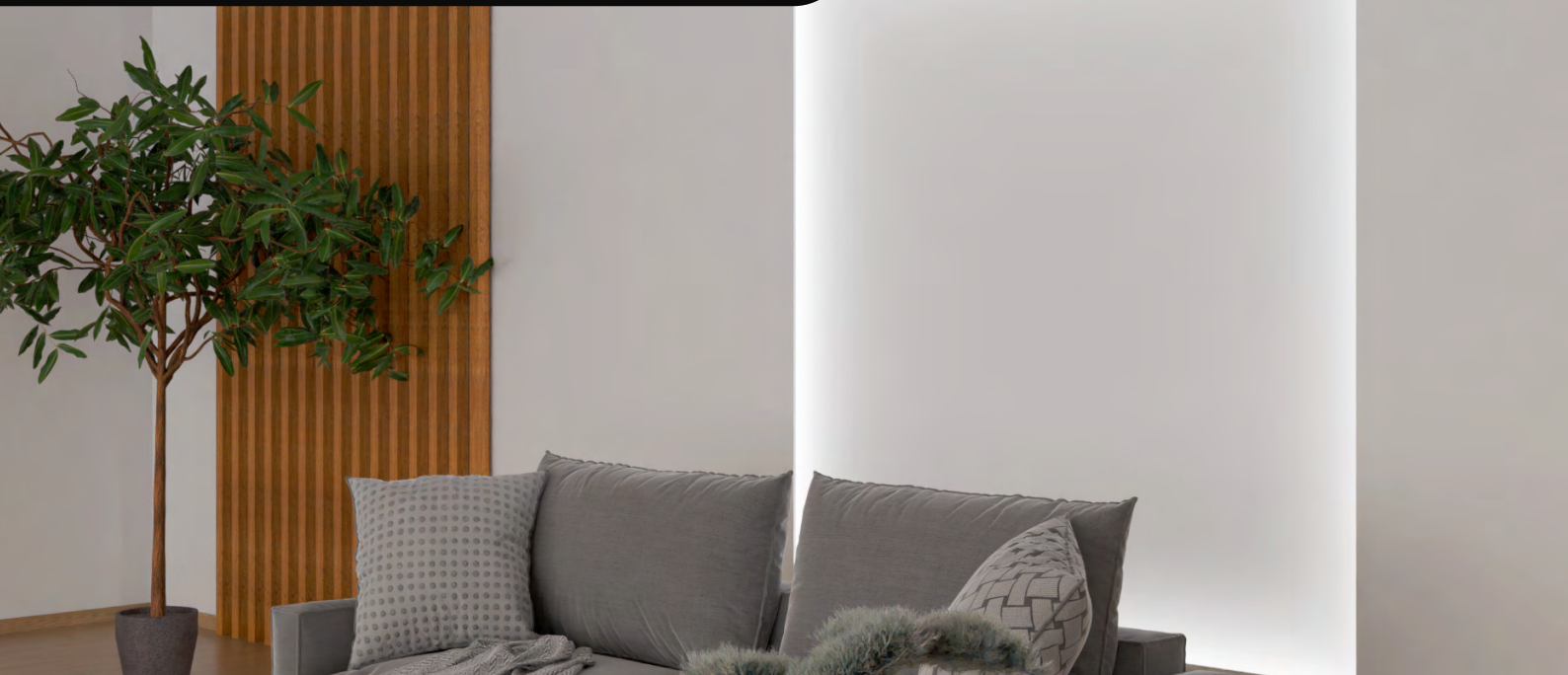

Codice Code	Lunghezza Length	Colore Color	Listino Price
PG165	2MT	Cartongesso	€ 125,00

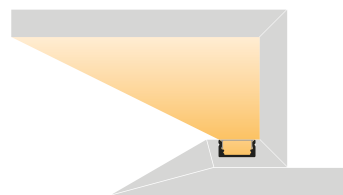
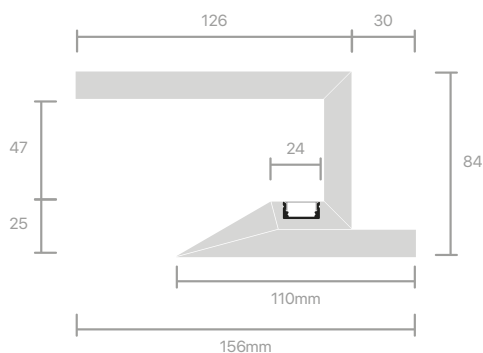

Accessori Accessories



EN110 - € 1,00
Tappo chiuso
Closed end cap



EN110/1 - € 1,00
Tappo forato
End cap with hole



PR990 - € 9,00
Schermo trasparente 2mt
Transparent cover 2mt



PR991 - € 10,50
Schermo opaco 2mt
White cover 2mt
PR991/10 - € 52,50
Schermo opaco 10mt
White cover 10mt

PG166 - Profilo incassato in Cartongesso
 PG166 - Profile embedded in plasterboard

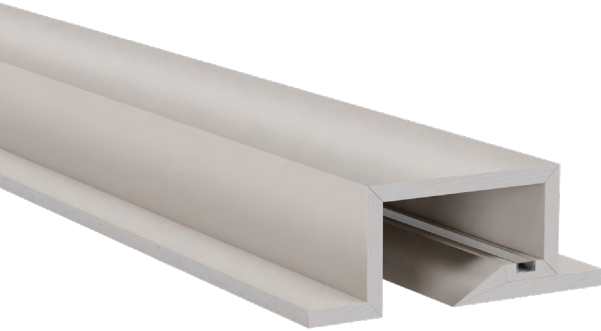

Codice Code	Lunghezza Length	Colore Color	Listino Price
● PG166	2MT	Cartongesso	€ 135,00

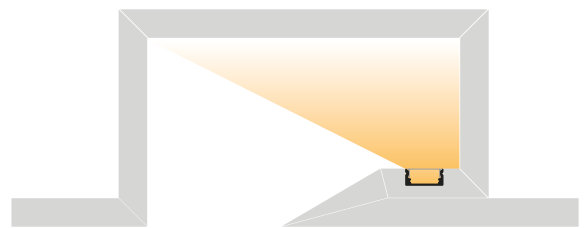
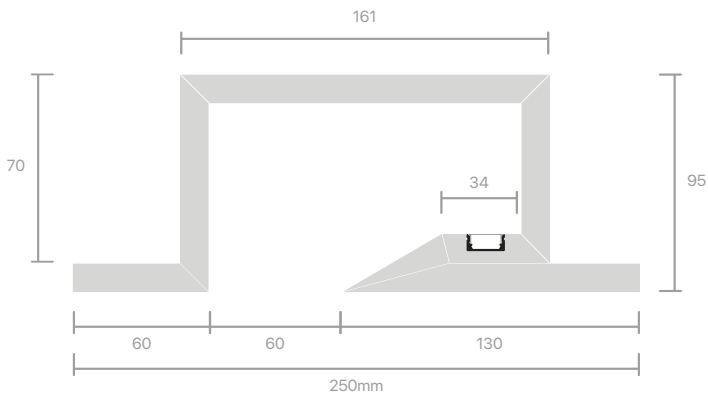

Accessori
 Accessories



EN110 - € 1,00
 Tappo chiuso
 Closed end cap



EN110/1 - € 1,00
 Tappo forato
 End cap with hole

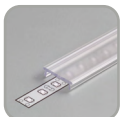

PR990 - € 9,00
 Schermo trasparente 2mt
 Transparent cover 2mt



PR991 - € 10,50
 Schermo opaco 2mt
 White cover 2mt

PR991/10 - € 52,50
 Schermo opaco 10mt
 White cover 10mt

PG245 - Profilo incassato in Cartongesso

PG245 - Profile embedded in plasterboard

Disponibile subito - Now available



Codice Code	Lunghezza Length	Colore Color	Listino Price
PG245	2MT	Cartongesso	€ 140,00

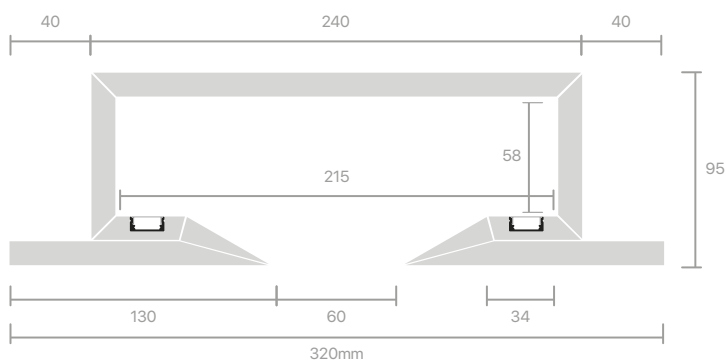

Accessori Accessories



EN110 - € 1,00
Tappo chiuso
Closed end cap



EN110/1 - € 1,00
Tappo forato
End cap with hole



PR990 - € 9,00
Schermo trasparente 2mt
Transparent cover 2mt



PR991 - € 10,50
Schermo opaco 2mt
White cover 2mt
PR991/10 - € 52,50
Schermo opaco 10mt
White cover 10mt





Sede / Headquarters
Via Nicola Ruffo, 27 - 70124 Bari - Italy

Tel. +39 080 504 6806

www.ledcoitalia.it | info@ledcoitalia.it