

NEWS 2023





Line48

Mini Darklight Tonda 1 - Mini Rounded Darklight 1	05
Mini Darklight Tonda 2 - Mini Rounded Darklight 2	06
Mini Darklight Tonda 3 - Mini Rounded Darklight 3	07
Mini Darklight Quadrata 1 - Mini Squared Darklight 1	08
Connettori Soffitto/Parete - Ceiling-Wall Connectors	11
Modulo magnetico per Strip LED 48V - Magnetic module for 48V LED Strip	13

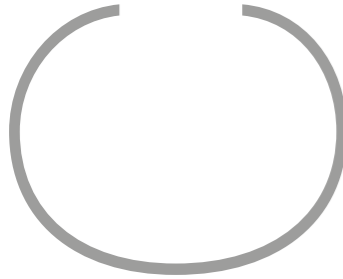

220V Series

Spot da incasso 5W - Recessed 220V Spot 5W	16
Spot da incasso 10W - Recessed 220V Spot 10W	17
Spot da incasso 20W - Recessed 220V Spot 20W	18
Spot da incasso 30W - Recessed 220V Spot 30W	19
Strip LED 220V - 220V LED Strip	20
Dimmer rotativo 220V - 220V Rotary Dimmer	21



LED Strip

Strip LED SL125 5mm - LED Strip SL125 5mm	23
--	-----------

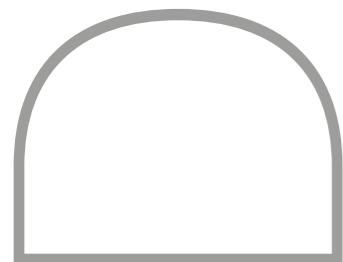

Flex Series

Tubo Luminoso Flex FL25 - Flex Light Tube FL25	25
Strip LED Flex 1010 - Flex 1010 LED Strip	34
Strip LED MiniFlex - MiniFlex LED Strip	35

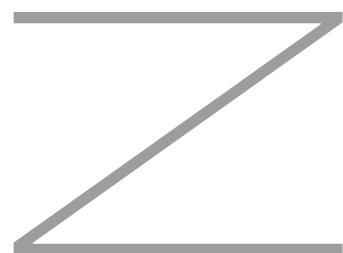

Octopus Series

Profilo Octopus FL129/2 - Octopus Profile FL129/2	36
Flangia Octopus FL129/C - Octopus Flange FL129/C	37



Schermi

Schermi da 10 metri - 10 meter diffusers	39
Schermi con alette - Diffusers with flaps	40

Accessori

Centralina scale sequenziali - Sequential stairs control unit	43
Accessori Strip LED Runner - Accessories Runner LED Strip	45
Connettori rapidi - Quick connectors	46



Mini Darklight Tonda 1
Mini Rounded Darklight 1

NEW

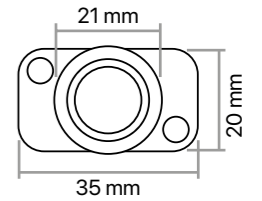
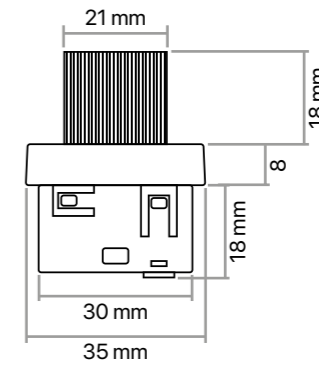

- Corpo in pressofusione di alluminio verniciato a polveri
- Fascio d'apertura 24°
- LED durata utile: 50 000 (h) L90
- Apparecchio IP20
- Chip CRI95 e 3 Step MacAdam

- Powder coated die-cast aluminum body
- Opening beam 24°
- LED useful life: 50 000 (h) L90
- IP20 device
- Chip CRI95 and 3 Step MacAdam

Codice Code	Colore Color	DC DC	Consumo Power	Lumen Lumen	Temp. Temp.	Listino Price
● MG01LBC/NE/T	Nero - Black	48V	1W	90	3000K	€ 55,00
● MG01LBN/NE/T	Nero - Black	48V	1W	95	4000K	€ 55,00

Prodotto compatibile con tutti i binari magnetici MG140, MG240 e MG540 (da pag. 12 del Catalogo Operativo 2023)

Product compatible with all magnetic tracks MG140, MG240 and MG540 (from page 12 of the 2023 Operative Catalogue)

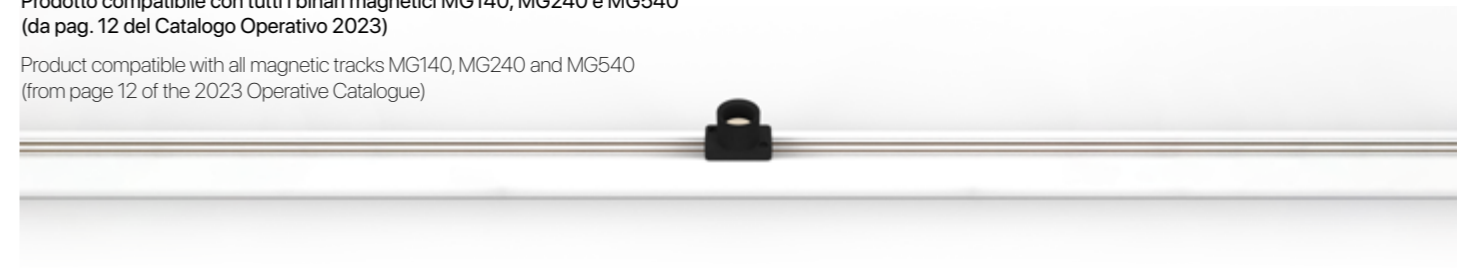

Cono di luce
Cone of light

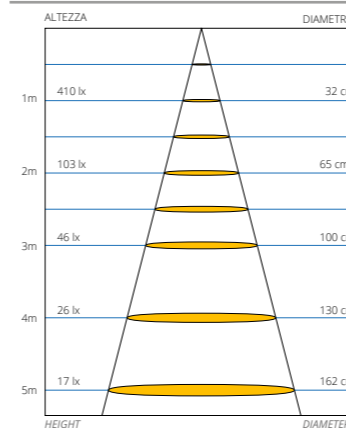

Curve fotometriche
Photometric curve

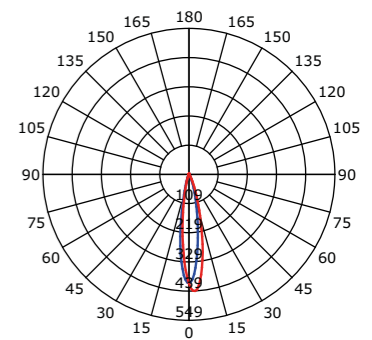
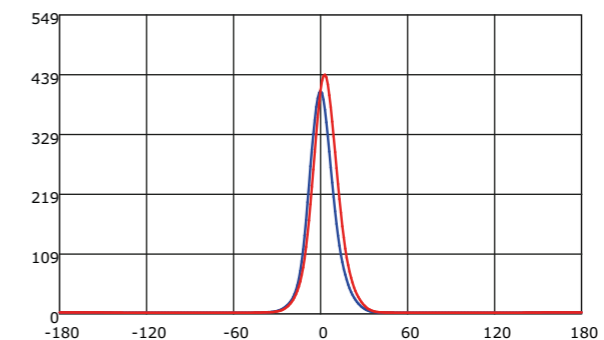

Mini Darklight Tonda 2

Mini Rounded Darklight 2

NEW

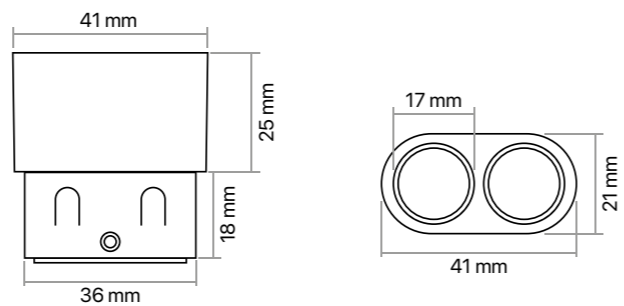

- Corpo in pressofusione di alluminio verniciato a polveri
- Fascio d'apertura 24°
- LED durata utile: 50 000 (h) L90
- Apparecchio IP20
- Chip CRI95 e 3 Step MacAdam

- Powder coated die-cast aluminum body
- Opening beam 24°
- LED useful life: 50 000 (h) L90
- IP20 device
- Chip CRI95 and 3 Step MacAdam

Codice Code	Colore Color	DC DC	Consumo Power	Lumen Lumen	Temp. Temp.	Listino Price
● MG02LBC/NE/T	Nero - Black	48V	2W	110	3000K	€ 71,00
● MG02LBN/NE/T	Nero - Black	48V	2W	125	4000K	€ 71,00

Prodotto compatibile con tutti i binari magnetici MG140, MG240 e MG540 (da pag. 12 del Catalogo Operativo 2023)

Product compatible with all magnetic tracks MG140, MG240 and MG540 (from page 12 of the 2023 Operative Catalogue)



Cono di luce

Cone of light

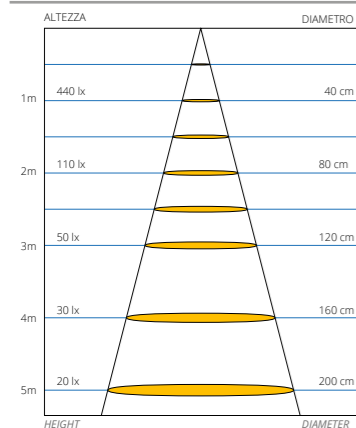

Curve fotometriche

Photometric curve

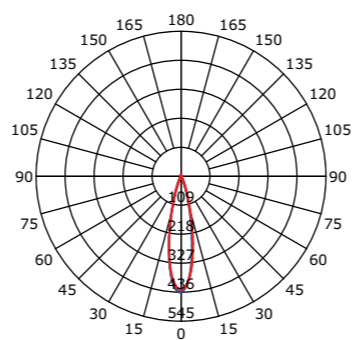
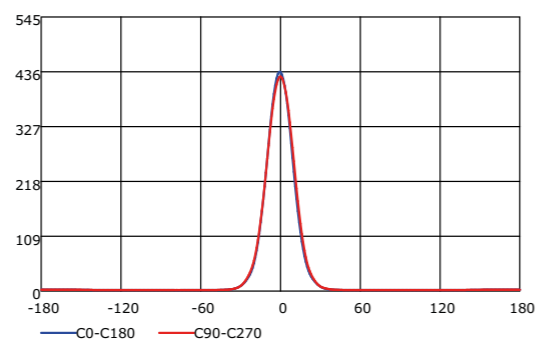

Mini Darklight Tonda 3

Mini Rounded Darklight 3

NEW

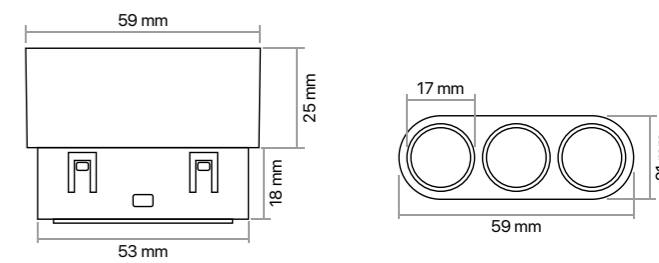

- Corpo in pressofusione di alluminio verniciato a polveri
- Fascio d'apertura 24°
- LED durata utile: 50 000 (h) L90
- Apparecchio IP20
- Chip CRI95 e 3 Step MacAdam

- Powder coated die-cast aluminum body
- Opening beam 24°
- LED useful life: 50 000 (h) L90
- IP20 device
- Chip CRI95 and 3 Step MacAdam

Codice Code	Colore Color	DC DC	Consumo Power	Lumen Lumen	Temp. Temp.	Listino Price
● MG03LBC/NE/T	Nero - Black	48V	3W	220	3000K	€ 85,00
● MG03LBN/NE/T	Nero - Black	48V	3W	240	4000K	€ 85,00

Prodotto compatibile con tutti i binari magnetici MG140, MG240 e MG540 (da pag. 12 del Catalogo Operativo 2023)

Product compatible with all magnetic tracks MG140, MG240 and MG540 (from page 12 of the 2023 Operative Catalogue)



Cono di luce

Cone of light

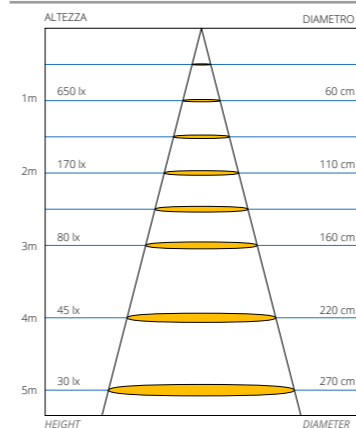

Curve fotometriche

Photometric curve

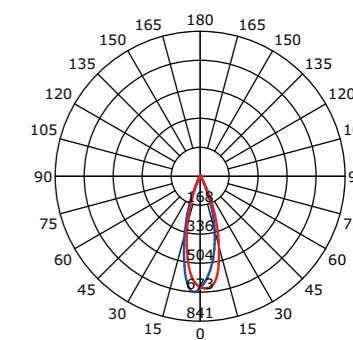
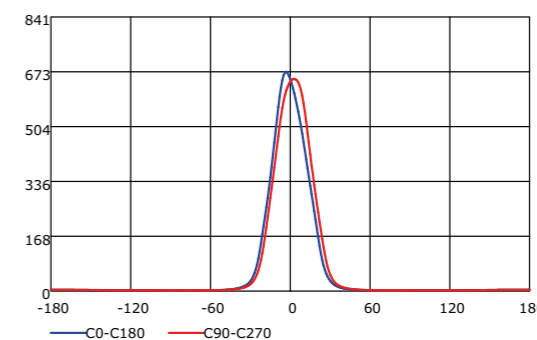

Mini Darklight Quadrata 1
Mini Squared Darklight 1

NEW

line48

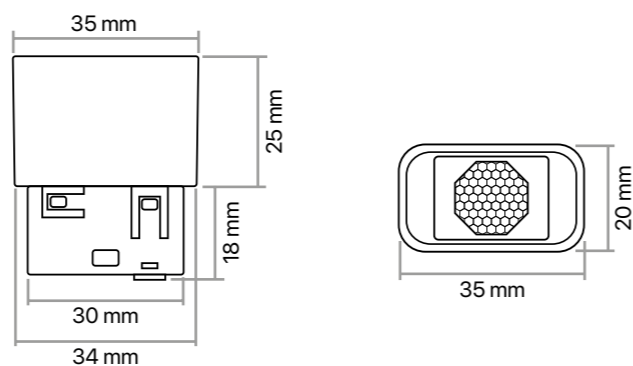

- Corpo in pressofusione di alluminio verniciato a polveri
- Fascio d'apertura 24°
- LED durata utile: 50 000 (h) L90
- Apparecchio IP20
- Chip CRI95 e 3 Step MacAdam

- Powder coated die-cast aluminum body
- Opening beam 24°
- LED useful life: 50 000 (h) L90
- IP20 device
- Chip CRI95 and 3 Step MacAdam

Codice Code	Colore Color	DC DC	Consumo Power	Lumen Lumen	Temp. Temp.	Listino Price
● MG01LBC/NE	Nero - Black	48V	1W	30	3000K	€ 50,00
● MG01LBN/NE	Nero - Black	48V	1W	75	4000K	€ 50,00

Prodotto compatibile con tutti i binari magnetici MG140, MG240 e MG540
(da pag. 12 del Catalogo Operativo 2023)

Product compatible with all magnetic tracks MG140, MG240 and MG540
(from page 12 of the 2023 Operative Catalogue)



Cono di luce
Cone of light

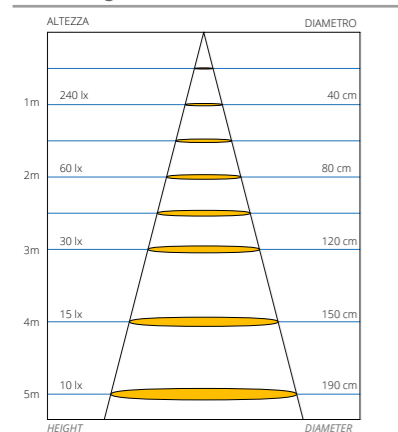

Curve fotometriche
Photometric curve

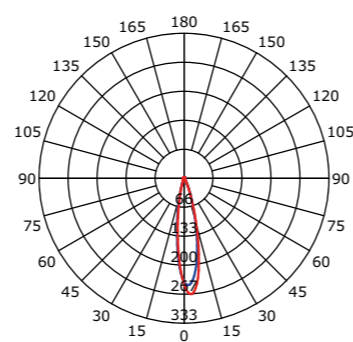
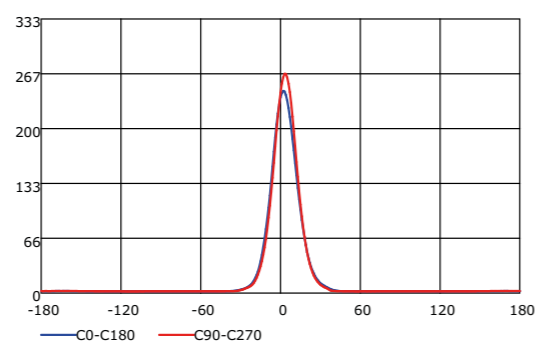

LEDCO®

Nuovi connettori Soffitto-Parete

New Ceiling-Wall connectors

Connettori Soffitto-Parete Ceiling-Wall Connectors

NEW

NEWS 2023

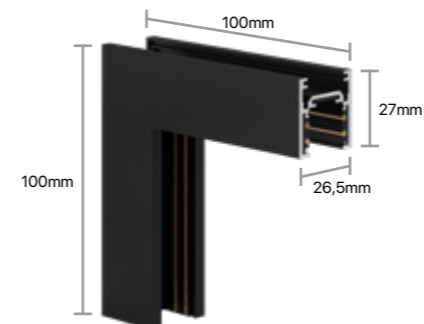

Codice Code	Colore Color	Listino Price
MGCO140/NE2/P	Nero - Black	€ 55,00
MGCO140/BI2/P	Bianco - White	€ 55,00

N.B. Prodotto completo di giunzioni per l'assemblaggio
P.S. Product complete with joints for assembly



PER CONNESSIONE ELETTRICA
FOR ELECTRICAL CONNECTION

MGCOF540/NE - € 30,50
Giunzione flessibile nera
Black flexible joint

MGCOF540/BI - € 30,50
Giunzione flessibile bianca
White flexible joint

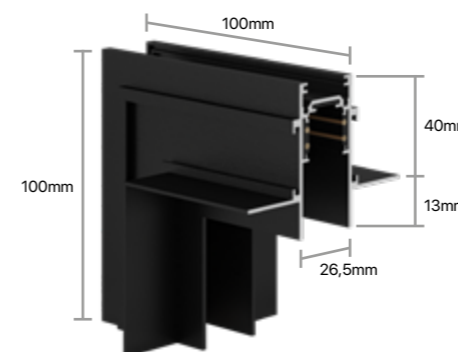

Codice Code	Colore Color	Listino Price
MGCO240/NE2/P	Nero - Black	€ 58,50
MGCO240/BI2/P	Bianco - White	€ 58,50

N.B. Prodotto completo di giunzioni per l'assemblaggio
P.S. Product complete with joints for assembly



PER CONNESSIONE ELETTRICA
FOR ELECTRICAL CONNECTION

MGCOF540/NE - € 30,50
Giunzione flessibile nera
Black flexible joint

MGCOF540/BI - € 30,50
Giunzione flessibile bianca
White flexible joint

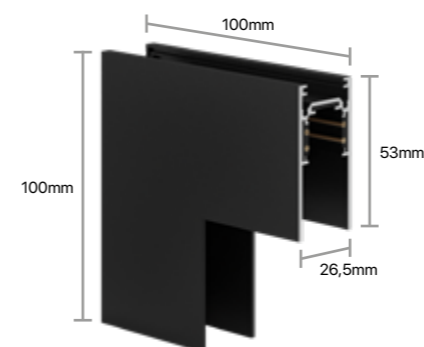

Codice Code	Colore Color	Listino Price
MGCO540/NE2/P	Nero - Black	€ 55,00
MGCO540/BI2/P	Bianco - White	€ 55,00

N.B. Prodotto completo di giunzioni per l'assemblaggio
P.S. Product complete with joints for assembly



PER CONNESSIONE ELETTRICA
FOR ELECTRICAL CONNECTION

MGCOF540/NE - € 30,50
Giunzione flessibile nera
Black flexible joint

MGCOF540/BI - € 30,50
Giunzione flessibile bianca
White flexible joint

Modulo magnetico per Strip LED 48V

Il modulo magnetico per strip LED a 48v è un dispositivo che permette di collegare una strip LED da 48v a un binario magnetico a bassa tensione. In questo modo, è possibile installare la strip sulla parte superiore del binario, così da avere luce indiretta sul soffitto, creando un'atmosfera accogliente e moderna.

Magnetic module for 48V LED Strips

The magnetic module for 48v LED strips is a device that allows you to connect a 48v LED strip to a low voltage magnetic track. In this way, it is possible to install the strip on the upper part of the track, so as to have indirect light on the ceiling, creating a welcoming and modern atmosphere.

Modulo magnetico per Strip LED 48V

Magnetic module for 48V LED strip

NEW

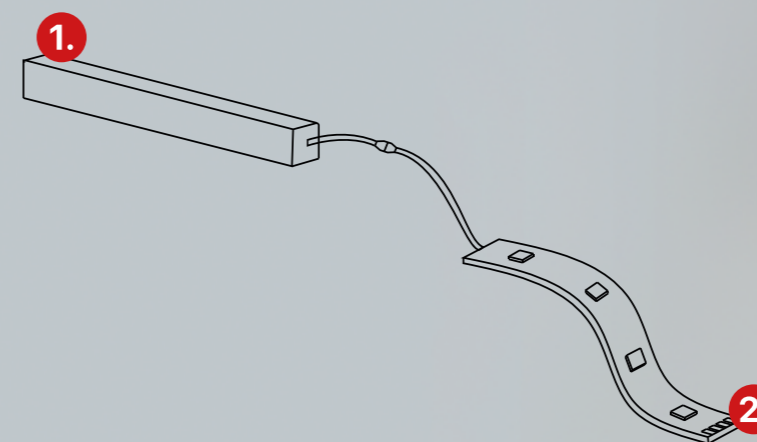

1.

MGAL/NE - € 22,50

Modulo alimentazione 4p magnetico nero
Black magnetic 4p power supply module

MGAL/BI - € 22,50

Modulo alimentazione 4p magnetico bianco
White magnetic 4p power supply module

+

Codice Code	Temp. Temp.	Lumen/MT Lumen/MT	Listino Price
SL120LBC20/48	3000K	1410	€ 22,00/mt
SL120LBN20/48	4000K	1450	€ 22,00/mt
SL120LBI20/48	6000K	1490	€ 22,00/mt
SL120LBC68/48	3000K	1410	€ 33,50/mt
SL120LBN68/48	4000K	1450	€ 33,50/mt
SL120LBI68/48	6000K	1490	€ 33,50/mt

Potrai ordinare la lunghezza della Strip LED in base alle tue esigenze
You can order the length of the LED Strip according to your needs



Puoi collegare la Strip LED, al modulo di alimentazione, praticando un foro sul fondo del binario.

You can connect the LED Strip to the power module by making a hole on the bottom of the track.

1. Modulo alimentazione
Power supply module

2. Strip LED 48V
48V LED Strip





Serie 220V

Illuminazione alla massima potenza.

220V Series

Lighting at maximum power.

Spot 220V da incasso - 5W
Recessed 220V Spot - 5W

NEW



Disponibili da Settembre 2023
Available from September 2023

Ø50/60mm

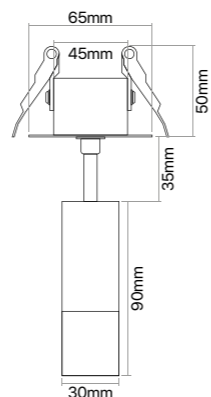

- Corpo in pressofusione di alluminio verniciato a polveri
- Fascio d'apertura standard 36°
- LED durata utile: 50000 (h) L90
- Apparecchio IP20
- Chip CRI95 e 3 Step MacAdam
- Diametro foro d'incasso 50/60mm

- Powder coated die-cast aluminum body
- Standard 36° opening beam
- LED useful life: 50000 (h) L90
- IP20 device
- CRI95 chip and 3 Step MacAdam
- Recessed hole diameter 50/60mm

Codice Code	Colore Color	AC AC	Consumo Power	Lumen Lumen	Temp. Temp.	Listino Price
PI05LBH/NE	Nero - Black	220V	5W	480	2700K	€ 80,00
PI05LBH/BI	Bianco - White	220V	5W	480	2700K	€ 80,00
PI05LBC/NE	Nero - Black	220V	5W	495	3000K	€ 80,00
PI05LBC/BI	Bianco - White	220V	5W	495	3000K	€ 80,00
PI05LBN/NE	Nero - Black	220V	5W	510	4000K	€ 80,00
PI05LBN/BI	Bianco - White	220V	5W	510	4000K	€ 80,00

Maggiorazioni Custom
Custom mark-up

Lenti - € 8,00

Lens

Cono di luce
Cone of light

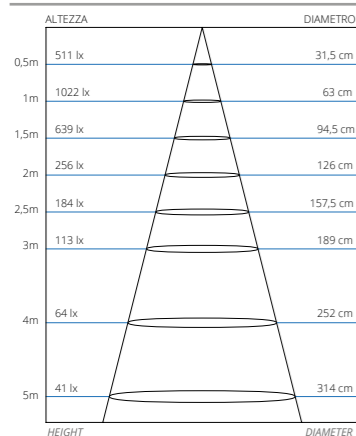

Curva fotometrica
Photometric curve

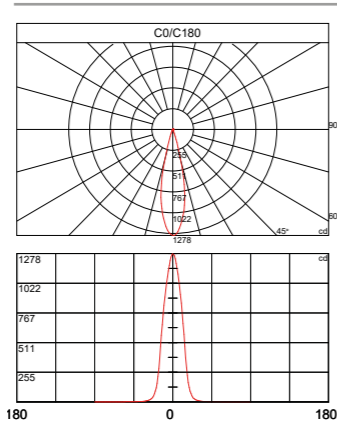

Fasci d'apertura
Opening beams

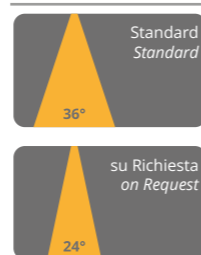

Spot 220V da incasso - 10W
Recessed 220V Spot - 10W

NEW



Disponibili da Settembre 2023
Available from September 2023

Ø50/60mm

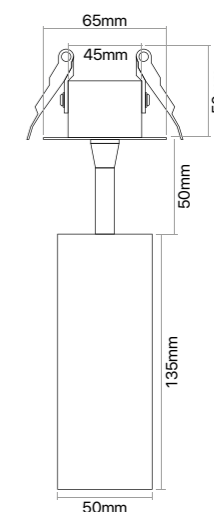

- Corpo in pressofusione di alluminio verniciato a polveri
- Fascio d'apertura standard 36°
- LED durata utile: 50000 (h) L90
- Apparecchio IP20
- Chip CRI95 e 3 Step MacAdam
- Diametro foro d'incasso 50/60mm

- Powder coated die-cast aluminum body
- Standard 36° opening beam
- LED useful life: 50000 (h) L90
- IP20 device
- CRI95 chip and 3 Step MacAdam
- Recessed hole diameter 50/60mm

Codice Code	Colore Color	AC AC	Consumo Power	Lumen Lumen	Temp. Temp.	Listino Price
PI10LBH/NE	Nero - Black	220V	10W	862	2700K	€ 140,00
PI10LBH/BI	Bianco - White	220V	10W	862	2700K	€ 140,00
PI10LBC/NE	Nero - Black	220V	10W	901	3000K	€ 140,00
PI10LBC/BI	Bianco - White	220V	10W	901	3000K	€ 140,00
PI10LBN/NE	Nero - Black	220V	10W	940	4000K	€ 140,00
PI10LBN/BI	Bianco - White	220V	10W	940	4000K	€ 140,00

Maggiorazioni Custom
Custom mark-up

Lenti - € 8,00

Lens

Cono di luce
Cone of light

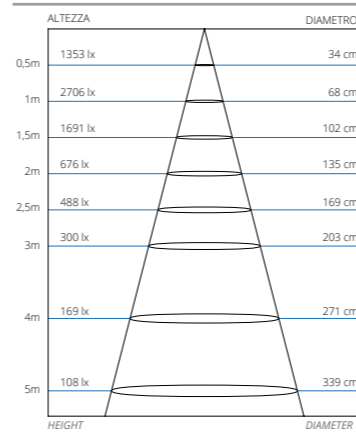

Curva fotometrica
Photometric curve

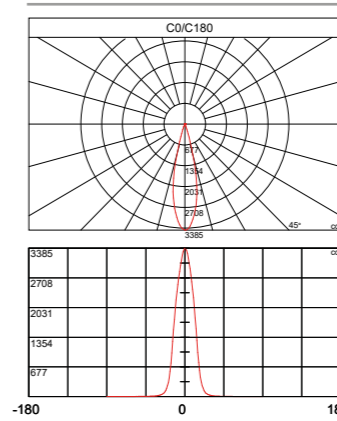

Fasci d'apertura
Opening beams



Spot 220V da incasso - 20W
Recessed 220V Spot - 20W

NEW



Disponibili da Settembre 2023
Available from September 2023

Ø50/60mm

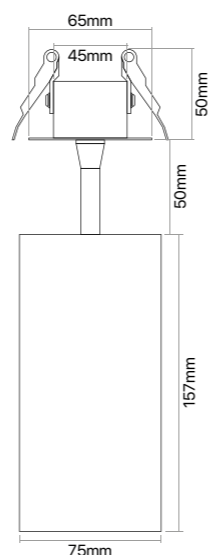

- Corpo in pressofusione di alluminio verniciato a polveri
- Fascio d'apertura standard 36°
- LED durata utile: 50000 (h) L90
- Apparecchio IP20
- Chip CRI95 e 3 Step MacAdam
- Diametro foro d'incasso 50/60mm

- Powder coated die-cast aluminum body
- Standard 36° opening beam
- LED useful life: 50000 (h) L90
- IP20 device
- CRI95 chip and 3 Step MacAdam
- Recessed hole diameter 50/60mm

Codice Code	Colore Color	AC AC	Consumo Power	Lumen Lumen	Temp. Temp.	Listino Price
PI20LBH/NE	Nero - Black	220V	20W	1960	2700K	€ 205,00
PI20LBH/BI	Bianco - White	220V	20W	1960	2700K	€ 205,00
PI20LBC/NE	Nero - Black	220V	20W	2010	3000K	€ 205,00
PI20LBC/BI	Bianco - White	220V	20W	2010	3000K	€ 205,00
PI20LBN/NE	Nero - Black	220V	20W	2058	4000K	€ 205,00
PI20LBN/BI	Bianco - White	220V	20W	2058	4000K	€ 205,00

Maggiorazioni Custom
Custom mark-up

Lenti - € 8,00

Lens

Cono di luce
Cone of light

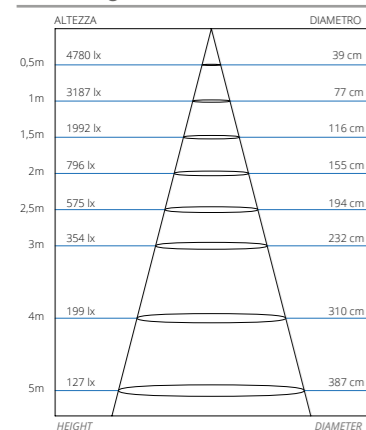

Curva fotometrica
Photometric curve

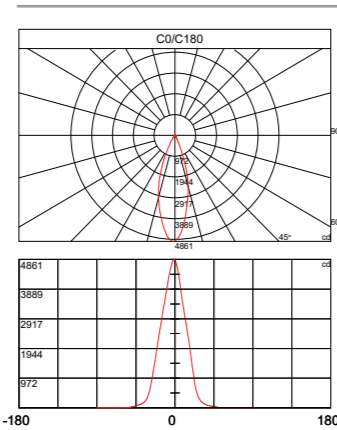

Fasci d'apertura
Opening beams

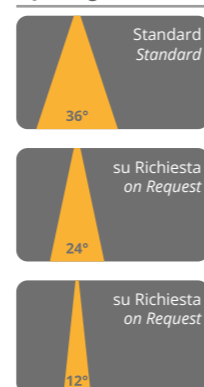

Spot 220V da incasso - 30W
Recessed 220V Spot - 30W

NEW



Disponibili da Settembre 2023
Available from September 2023

Ø50/60mm

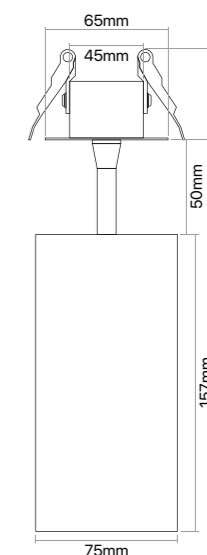

- Corpo in pressofusione di alluminio verniciato a polveri
- Fascio d'apertura standard 36°
- LED durata utile: 50000 (h) L90
- Apparecchio IP20
- Chip CRI95 e 3 Step MacAdam
- Diametro foro d'incasso 50/60mm

- Powder coated die-cast aluminum body
- Standard 36° opening beam
- LED useful life: 50000 (h) L90
- IP20 device
- CRI95 chip and 3 Step MacAdam
- Recessed hole diameter 50/60mm

Codice Code	Colore Color	AC AC	Consumo Power	Lumen Lumen	Temp. Temp.	Listino Price
PI30LBH/NE	Nero - Black	220V	30W	2860	2700K	€ 220,00
PI30LBH/BI	Bianco - White	220V	30W	2860	2700K	€ 220,00
PI30LBC/NE	Nero - Black	220V	30W	2910	3000K	€ 220,00
PI30LBC/BI	Bianco - White	220V	30W	2910	3000K	€ 220,00
PI30LBN/NE	Nero - Black	220V	30W	2958	4000K	€ 220,00
PI30LBN/BI	Bianco - White	220V	30W	2958	4000K	€ 220,00

Maggiorazioni Custom
Custom mark-up

Lenti - € 8,00

Lens

Cono di luce
Cone of light

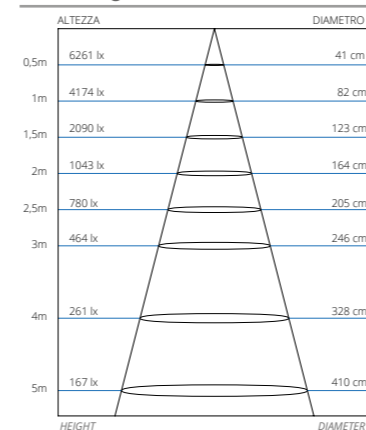

Curva fotometrica
Photometric curve

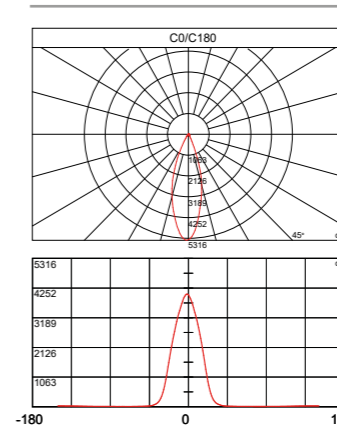

Fasci d'apertura
Opening beams

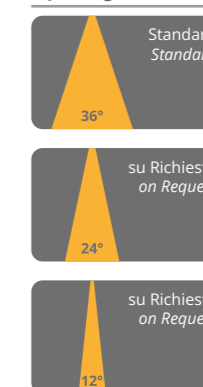

Strip LED 220V

220V LED Strip



- Strip flessibile per illuminazione lineare con LED monocromatico, bobina da 5 metri, 10 metri, 20 metri, 50 metri
- Sezionabile ad interassi prefissati ogni 10 cm
- Protezione attiva contro corto circuito
- IP65 con estrusione di elastomero silconico termo-dissipante all'interno
- Nastro adesivo VBH 3M sul retro
- Chip con CRI90+ e 3 Step MacAdam
- Collegabile alla rete senza il bisogno di un raddrizzatore supplementare

- Flexible strip for linear lighting with monochromatic LED. 5 meters, 10 meters, 20 meters, 50 meters reel
- Cutable on fixed point every 10 cm
- Active protection against short circuit
- IP65 with thermo-dissipating silicone elastomer extrusion inside
- VBH 3M sticker tape on the strip back
- CRI90+ and 3 Step MacAdam chip LED
- Connectable to the mains without the need for an additional rectifier

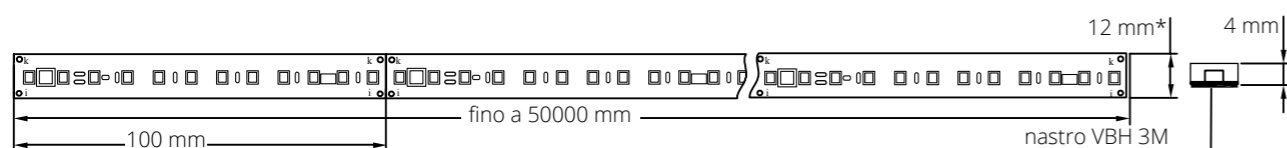

*con l'aggiunta del tappo la larghezza sarà 13mm, lo spessore 5mm | *with the addition of the cap the width will be 13mm, the thickness 5mm

Codice Code	IP IP	Lunghezza Length	W/MT W/MT	Temp. Temp.	LED/MT LED/MT	Lumen/MT Lumen/MT	AC AC	Listino Price
NEW SLP220LBH65	65	5 metri	16W/MT	2700K	120	2640	220V	€ 37,00/MT
SLP220LBC65	65	5 metri	16W/MT	3000K	120	2700	220V	€ 37,00/MT
SLP220LBN65	65	5 metri	16W/MT	4000K	120	2740	220V	€ 37,00/MT
SLP220LBI65	65	5 metri	16W/MT	6000K	120	2800	220V	€ 37,00/MT
NEW SLP220LBH65/10	65	10 metri	16W/MT	2700K	120	2640	220V	€ 37,00/MT
SLP220LBC65/10	65	10 metri	16W/MT	3000K	120	2700	220V	€ 37,00/MT
SLP220LBN65/10	65	10 metri	16W/MT	4000K	120	2740	220V	€ 37,00/MT
SLP220LBI65/10	65	10 metri	16W/MT	6000K	120	2800	220V	€ 37,00/MT
NEW SLP220LBH65/20	65	20 metri	16W/MT	2700K	120	2640	220V	€ 37,00/MT
SLP220LBC65/20	65	20 metri	16W/MT	3000K	120	2700	220V	€ 37,00/MT
SLP220LBN65/20	65	20 metri	16W/MT	4000K	120	2740	220V	€ 37,00/MT
SLP220LBI65/20	65	20 metri	16W/MT	6000K	120	2800	220V	€ 37,00/MT
NEW SLP220LBH65/50	65	50 metri	16W/MT	2700K	120	2640	220V	€ 37,00/MT
SLP220LBC65/50	65	50 metri	16W/MT	3000K	120	2700	220V	€ 37,00/MT
SLP220LBN65/50	65	50 metri	16W/MT	4000K	120	2740	220V	€ 37,00/MT
SLP220LBI65/50	65	50 metri	16W/MT	6000K	120	2800	220V	€ 37,00/MT

Accessori Accessories



EN720 - € 0,80
Tappo di chiusura
End cap



EN720/1 - € 0,80
Tappo con foro
End cap with hole



EN68/12 - € 1,00
Staffe per montaggio a parete
Brackets for wall mounting



Dimmer Rotativo 220V

220V Rotary Dimmer

NEW



Per maggiori informazioni scansiona il QR Code



DM200/220 - Dimmer Rotativo 220V - € 110,00

DM200/220 - 220V Rotary Dimmer

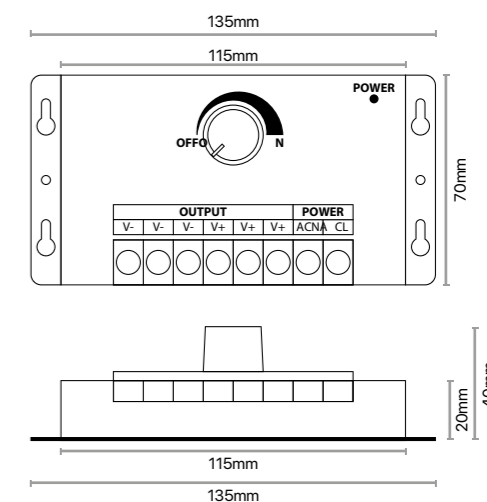

- Dimmer per Strip LED 220V
- Dimmerazione a taglio di fase
- Controllo tramite potenziometro rotativo o con il telecomando
- Uscita: 1CH max 10A - MAX 2300W

- Dimmer for 220V LED Strips
- Phase cut dimming
- Control via rotary potentiometer or with the remote control
- Output: 1CH max 10A - MAX 2300W

Strip LED SL125 - 5mm

LED Strip SL125 - 5mm



- Strip led flessibile per illuminazione lineare con LED monocromatico, bobina da 5 metri
- Sezionabile ad interassi prefissati ogni 5 cm
- Nastro adesivo 3M 300LSE sul retro, alto potere adesivo anche su profili verniciati a polveri
- La doppia intestazione di cavi permette una connessione in serie più rapida
- La pista flessibile miniaturizzata a soli 5mm permette l'installazione anche in spazi molto piccoli

- The 5 meters flexible reel provides a linear monochromatic LED lightning
- Cuttable every 5 cm
- 3M 300LSE adhesive tape on the back, high adhesive power even on powder coated profiles
- Cables on both sides guarantee a faster in series connection
- The miniaturized flexible track of just 5 mm allows installation even in very small spaces

... Elimina l'effetto puntinato con i profili
(vedi pag. 118 del Catalogo Operativo 2023)
Eliminate the dotted effect with profiles
(see page 118 of the 2023 Operating Catalogue)

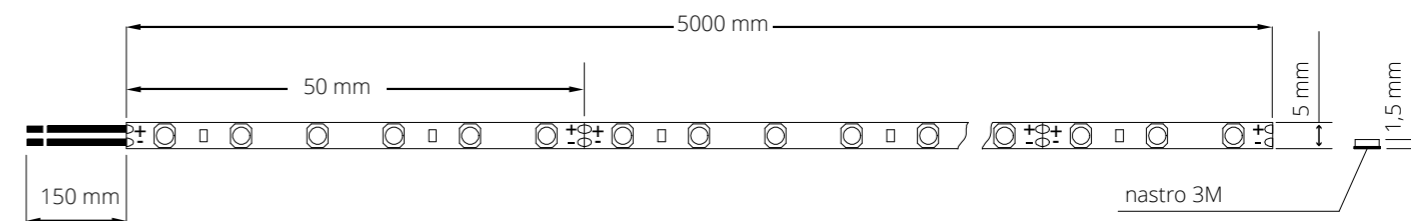

Codice Code	IP	Consumo Power	W/MT W/MT	Temp. Temp.	LED/MT LED/MT	Lumen/MT Lumen/MT	Lumen Lumen	DC DC	Listino Price
NEW SL125LBH20	20	80W	16W/MT	2700K	120	2660	13300	24V	€ 95,00
SL125LBC20	20	80W	16W/MT	3000K	120	2700	13500	24V	€ 95,00
SL125LBN20	20	80W	16W/MT	4000K	120	2740	13700	24V	€ 95,00
SL125LBI20	20	80W	16W/MT	6000K	120	2800	14000	24V	€ 95,00

IP68 Versione IP68 a pag. 90 del Catalogo Operativo 2023
IP68 version on page 90 of 2023 Operating Catalogue



CUSTOM

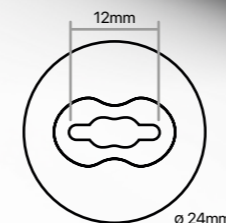

Il TUBO LUMINOSO FLEX CUSTOM è un sistema di illuminazione a LED che può essere piegato e modellato in diverse forme.

È ideale per creare effetti luminosi originali e personalizzati, sia per interni che per esterni.

Lunghezza massima 5 mt. IP65. Autodissipante.

The FLEX CUSTOM LIGHT TUBE is a LED lighting system that can be bent and molded into different shapes.

It is ideal for creating original and customized lighting effects, both for indoors and outdoors.

1. Scegli la strip compatibile

1. Choose the compatible strip

Codice Code	W/MT W/MT	Listino Price
SL120ES	16W/MT	€ 110,00/MT

Accessori
Accessories



FL25CL - € 3,00
Staffa per Tubo Flex
Bracket for Flex Tube

Applicazioni possibili

Possible applications

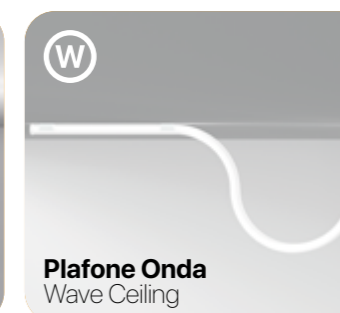
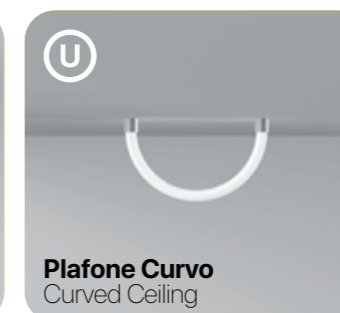

Serie Flex Custom

Prodotti flessibili custom IP65 con Strip LED e lunghezza a scelta.

Custom Flex Series

IP65 custom flexible products with LED Strip and length of your choice.

FL25/P - Tubo Flex a Plafone
FL25/P - Ceiling Flex Tube

NEW

Disponibili da Agosto 2023
Available from August 2023



FL25/V - Tubo Flex a Sospensione Verticale
FL25/V - Vertical Suspension Flex Tube

NEW

Disponibili da Agosto 2023
Available from August 2023



FL25/P

Il Tubo Flex a Plafone è un'innovativa soluzione di illuminazione che combina design, funzionalità ed efficienza energetica. È un tubo in policarbonato trasparente con al suo interno la sorgente luminosa rivestita in silicone con fissaggio a soffitto che proietta una luce diffusa ed omogenea lungo tutta la sua lunghezza. È disponibile in lunghezze customizzate e quattro temperature di colore.

The ceiling-mounted Flex Tube is an innovative lighting solution that combines design, functionality and energy efficiency. It is a transparent polycarbonate tube with a silicone-coated light source inside, fixed to the ceiling that casts a diffused and homogeneous light along its entire length. It is available in custom lengths and four color temperatures.

Codice Code	Listino Price
FL25/P	€ 190,00 (fino a 1MT)
FL25/P	€ 240,00 (fino a 2MT)

*Lunghezza massima 2MT
*Maximum length 2MT

**Prodotto consegnato assemblato nella personalizzazione scelta e predisposto al montaggio a plafone.
**Product delivered assembled in the chosen customization and ready for ceiling mounting.

FL25/V

Tubo in policarbonato trasparente con sorgente luminosa rivestita in silicone e fissaggio a sospensione. È personalizzabile in base alle tue esigenze: puoi scegliere la lunghezza e la temperatura di colore. Il suo cavo flessibile (lungo massimo 1.50 metri) permette una facile installazione regolabile in altezza.

Transparent polycarbonate tube with silicone-coated light source and suspension fixture. It can be customized according to your needs: you can choose the length and color temperature. Its flexible cable (maximum 1.50 meters long) allows an easy height-adjustable installation.

Codice Code	Listino Price
FL25/V	€ 190,00 (fino a 1MT)
FL25/V	€ 240,00 (fino a 2MT)

*Lunghezza massima 2MT
*Maximum length 2MT

**Prodotto consegnato assemblato nella personalizzazione scelta e predisposto al montaggio a sospensione.
**Product delivered assembled in the chosen customization and ready for suspension mounting.

FL25/U - Tubo Flex a Plafone Curvo
FL25/U - Curved Ceiling Flex Tube

NEW

Disponibili da Agosto 2023
Available from August 2023



FL25/U

Tubo flessibile curvo fissato al soffitto in grado di creare un effetto luminoso scenografico. È disponibile in lunghezze customizzate e in varie temperature di colore, per adattarsi ad ogni tipo di spazio e di arredamento. Il Tubo Flex a Plafone Curvo è ideale per chi cerca una soluzione di illuminazione originale.

Curved flexible tube fixed to the ceiling able to create a scenographic luminous effect. It is available in customized lengths and in various color temperatures, so as to adapt to any type of space and décor. The Curved Ceiling Flex Tube is ideal for those looking for an original lighting solution.

Codice Code	Listino Price
FL25/U	€ 110,00/MT

*Lunghezza massima 5MT
*Maximum length 5MT

**Prodotto consegnato assemblato nella personalizzazione scelta e predisposto al montaggio a plafone.
**Product delivered assembled in the chosen customization and ready for ceiling mounting.

FL25/O - Tubo Flex a Sospensione Orizzontale
FL25/O - Horizontal Suspension Flex Tube

NEW

Disponibili da Agosto 2023
Available from August 2023

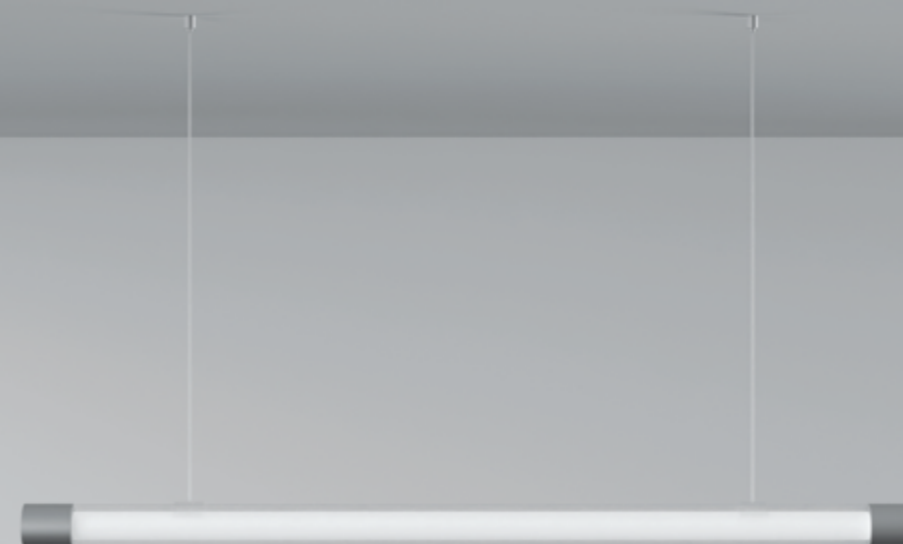

FL25/O

Il Tubo Flex a Sospensione Orizzontale ti sorprenderà per il suo design minimale. È personalizzabile in base alle tue preferenze: si può scegliere la lunghezza e la tonalità della luce. Questo prodotto è facile da installare e da regolare in altezza, grazie al cavo flessibile (lungo massimo 1.50 metri).

The Horizontal Suspension Flex Tube will surprise you with its minimal design. It can be customized according to your preferences: you can choose the length and tone of the light. This product is easy to install and adjust in height, thanks to the flexible cable (maximum 1.50 meters long).

Codice Code	Listino Price
FL25/O	€ 190,00 (fino a 1MT)

*Lunghezza massima 1MT
*Maximum length 1MT

**Prodotto consegnato assemblato nella personalizzazione scelta e predisposto al montaggio a sospensione.
**Product delivered assembled in the chosen customization and ready for suspension mounting.

FL25/C - Tubo Flex a Sospensione Circolare
FL25/C - Circular Suspension Flex Tube

NEW

Disponibili da Agosto 2023
Available from August 2023



FL25/C

Il Tubo Flex a Sospensione Circolare è personalizzabile in base alle tue esigenze, scegliendo la tonalità della luce, tra calda, neutra o fredda. Grazie al suo cavo flessibile (lungo massimo 1.50 metri), è facile da installare e da regolare in altezza.

The Circular Suspension Flex Tube can be customized according to your needs, choosing the tone of the light, among warm, neutral or cold. Thanks to its flexible cable (maximum 1.50 meters long), it is easy to install and adjust in height.

*Diametro 30cm
*Diameter 30cm

**Prodotto consegnato assemblato nella personalizzazione scelta e predisposto al montaggio a sospensione.
**Product delivered assembled in the chosen customization and ready for suspension mounting.

Codice Code	IP IP	Consumo Power	Colore L. L. Color	Diametro Diameter	Lumen Lumen	DC DC	Listino Price
● FL25/LBH120ES/C	65	16W	2700K	ø 30cm	1925	24V	€ 110,00
● FL25/LBC120ES/C	65	16W	3000K	ø 30cm	2030	24V	€ 110,00
● FL25/LBN120ES/C	65	16W	4000K	ø 30cm	2090	24V	€ 110,00
● FL25/LBI120ES/C	65	16W	6000K	ø 30cm	2150	24V	€ 110,00

FL25/T - Tubo Flex a Sospensione con Tige
FL25/T - Suspension Flex Tube with Tige

NEW

Disponibili da Agosto 2023
Available from August 2023



FL25/T

Tubo flessibile in silicone, completo di terminali in alluminio e cavo di alimentazione.

Si fissa al soffitto, tramite tige metallica bianca.

È personalizzabile in base alle tue esigenze: si può scegliere la lunghezza e la tonalità della luce.

È facile da installare e da regolare in altezza, grazie al suo sistema di sospensione allungabile (lunghezza minima 34cm - massima 62cm).

Flexible silicone tube, complete with aluminum terminals and power cord. It is fixed to the ceiling with a white metal tige. It can be customized according to your needs: you can choose the length and the shade of the light. It is easy to install and to adjust in height, thanks to its extendable suspension system (minimum length 34cm - maximum 62cm).

Codice Code	Listino Price
FL25	€ 110,00/MT

FL25/T - € 22,00/pz.

*Lunghezza massima 5MT
*Maximum length 5MT

**Prodotto consegnato assemblato nella personalizzazione scelta e predisposto al montaggio a sospensione.
**Product delivered assembled in the chosen customization and ready for suspension mounting.



FL25/W

Tubo flessibile in silicone, completo di un terminale in alluminio e uno in silicone bianco.

Disponibile in lunghezze customizzate, fino ad un massimo di 5 metri.

L'ancoraggio principale e l'alimentazione sono garantiti dalla testata di copertura in alluminio.

Sono disponibili staffe in policarbonato trasparente, per un fissaggio a parete/soffitto del tubo.

Flexible silicone tube, complete with an aluminum terminal and a white silicone one.

Available in customized lengths, up to a maximum of 5 metres.

The main anchorage and power supply are guaranteed by the aluminum cover head.

Transparent polycarbonate brackets are available for wall/ceiling fixing of the tube.

Codice Code	Listino Price
FL25/W	€ 110,00/MT

Accessori Accessories



FL25CL - € 3,00
Staffa per Tubo Flex
Bracket for Flex Tube

*Lunghezza massima 5MT
*Maximum length 5MT

**Prodotto consegnato assemblato nella personalizzazione scelta e predisposto al montaggio a plafone.

**Product delivered assembled in the chosen customization and ready for ceiling mounting.

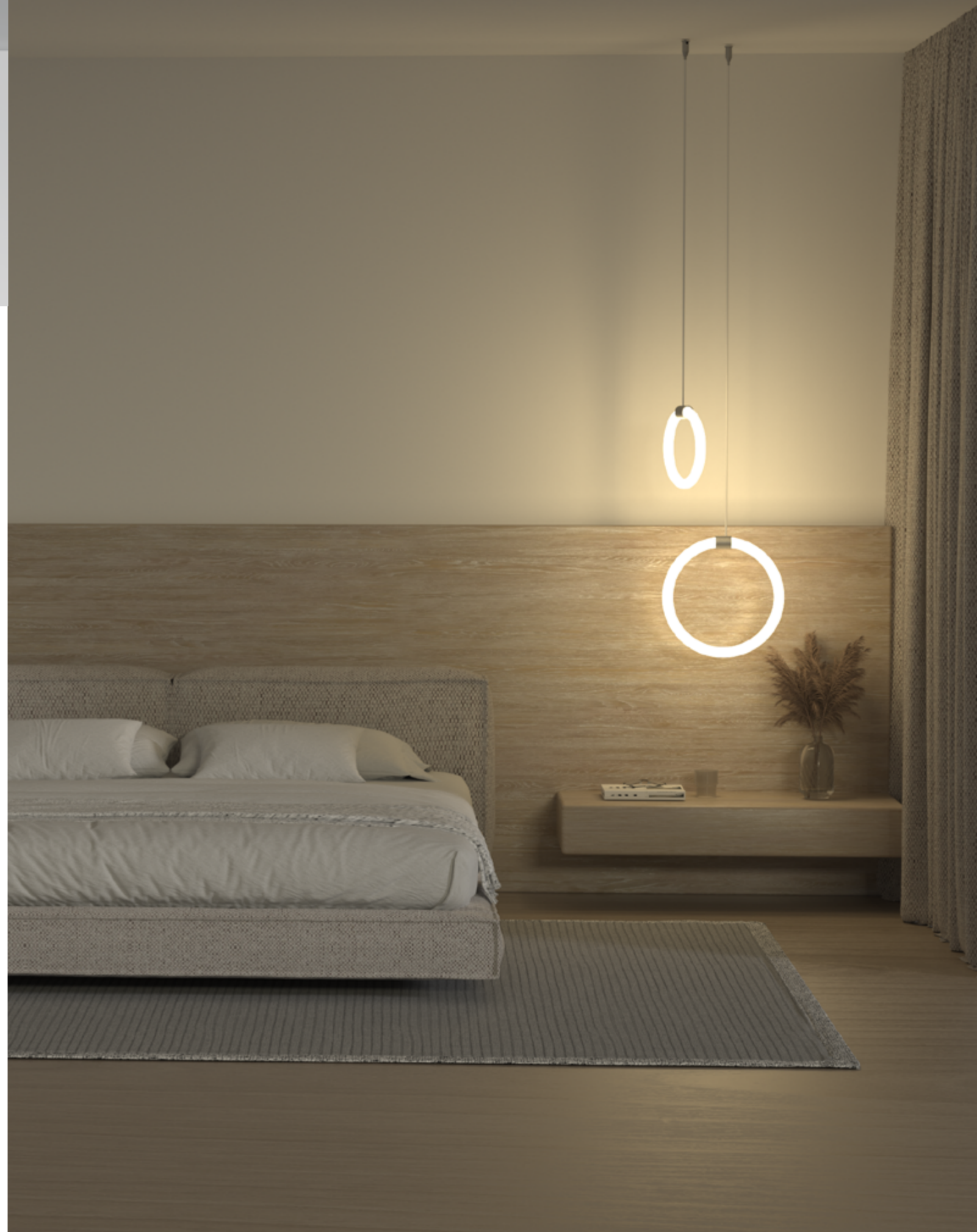

Strip LED Flex 1010
Flex 1010 LED strip

NEW

CUSTOM



DOPPIA INTESAZIONE - 25 €
Consigliato per lunghezze superiori a 5 mt

DOUBLE HEADING - 25 €
Recommended for lengths over 5 m

La strip LED FLEX CUSTOM ti permette di scegliere la lunghezza più adatta alle tue esigenze, ricevendo direttamente il prodotto finito pronto per l'installazione.

Lunghezza massima 10 mt. IP 65. Autodissipante.

The custom flex LED strip allows you to choose the length that best suits your needs, directly receiving the finished product ready for installation.

Maximum length 10 meters. IP 65. Self dissipating.

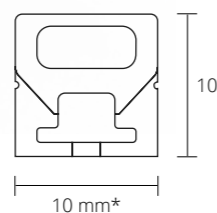
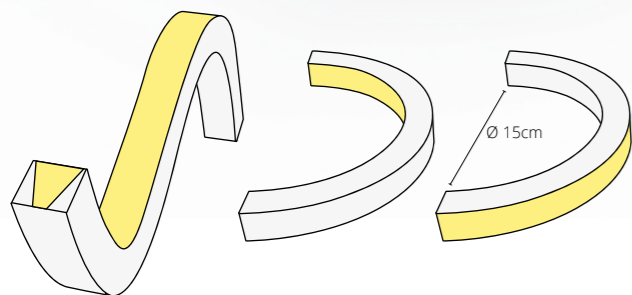

FL1010
Tubo vuoto flex 10x10mm in silicone.
Dimensioni con tappi 12x12mm.

Empty flex tube 10x10mm silicone.
Size with caps 12x12mm.

1. Scegli la strip compatibile

1. Choose the compatible strip

Codice Code	W/MT W/MT	Listino Price
SL125	16W/MT	€ 50,00/MT

2. Tipologia di fissaggio

2. Type of fixing

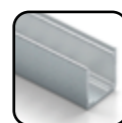

Profilo FL220CL2 - € 22,50
Profilo in alluminio 2mt
Aluminum profile 2mt



FL220CL - € 1,20
Staffa di fissaggio
Mounting plate

Accessori
Accessories



FL1010TA - € 1,00
Tappo chiuso
Closed end cap



FL1010TA/1 - € 1,00
Tappo forato
End cap with hole



Strip LED MiniFlex
MiniFlex LED Strip

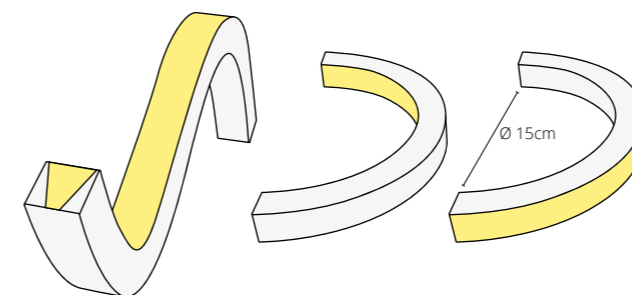
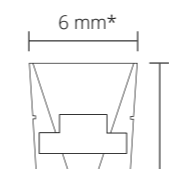
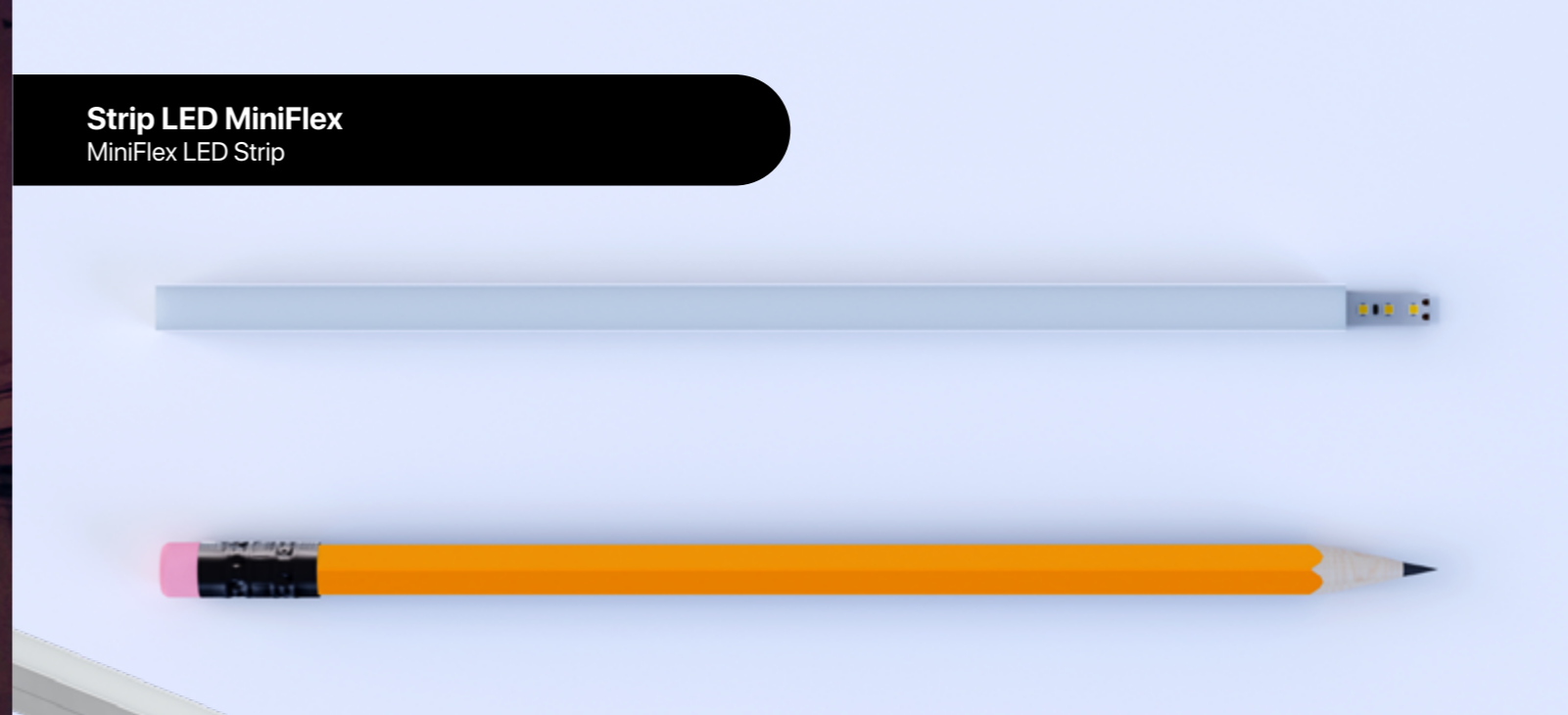

- Strip led flessibile miniaturizzata per illuminazione lineare da esterno o interno, lunghezza 5 mt. Dimensione tubo flex in silicone 6x6 mm*
- Sezionabile ogni 4 cm;
- Per il fissaggio usare le staffe o il profilo, ordinabili separatamente;
- L'elevata densità dei LED consente un'illuminazione omogenea;
- Autodissipante;
- Diffusore opale.

- Mini flex strip led for outdoor/indoor linear lighting, 5 meter length. 6x6 mm silicone flex tube size*
- Cuttable every 4 cm
- To install it, you can use the hanging clips or the profile
- High LED density provides an uniform lightning on every surface
- Self-dissipating
- Opal screen

* Dimensione tubo Flex con aggiunta di tappo 7x7mm

* Flex tube size with the addition of cap 7x7mm

Codice Code	IP IP	W/MT W/MT	Temp. Temp.	Lumen Lumen	Lumen/MT Lumen/MT	DC DC	Listino Price
NEW FLM24LBH65	65	16W/MT	2700K	2950	590	24V	€ 150,00
FLM24LBC65	65	16W/MT	3000K	3050	610	24V	€ 150,00
FLM24LBN65	65	16W/MT	4000K	3150	630	24V	€ 150,00
FLM24LBI65	65	16W/MT	6000K	3300	660	24V	€ 150,00

Tipologia di fissaggio
Type of fixing



Profilo PR113 - € 20,50
Profilo in alluminio 2mt
Aluminum profile 2mt



FL220CL - € 1,20
Staffa di fissaggio
Mounting plate



FLM24TA - € 1,00
Tappo chiuso
Closed end cap



FLM24TA/1 - € 1,00
Tappo forato
End cap with hole

Accessori
Accessories



FL129/2 - Profilo Octopus
FL129/2 - Octopus Profile

NEW

Disponibili da Settembre 2023
Available from September 2023



*Tappi esterni al profilo (come foto).
*Caps outside the profile (as in the photo).



Codice Code	Lunghezza Length	Colore Color	Listino Price
FL129/2	2 MT	Silver	€ 55,00

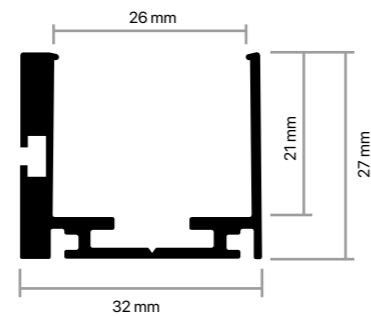

FL129/C - Flangia Octopus
FL129/C - Octopus Flange

NEW

Disponibili da Settembre 2023
Available from September 2023

CUSTOM



*I terminali dell'OCTOPUS verranno nascosti dalla Flangia.
*The OCTOPUS terminals will be hidden by the Flange.

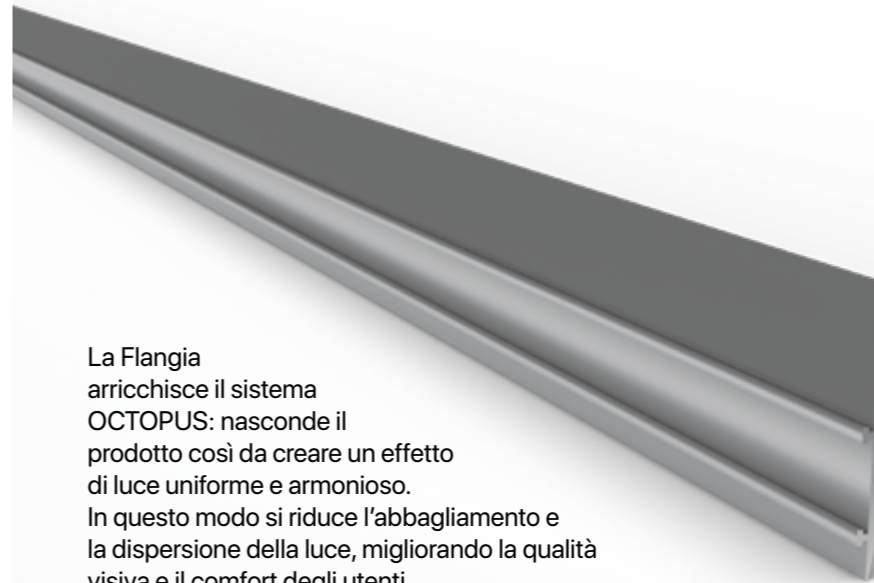

Codice Code	Lunghezza Length	Colore Color
FL129/C	2 MT	Custom

*COLORI RAL CUSTOMIZZABILI
*CUSTOMIZABLE RAL COLORS

La Flangia arricchisce il sistema OCTOPUS: nasconde il prodotto così da creare un effetto di luce uniforme e armonioso. In questo modo si riduce l'abbagliamento e la dispersione della luce, migliorando la qualità visiva e il comfort degli utenti. La customizzazione del colore del prodotto contribuisce a dare un tocco di stile e personalità al sistema di illuminazione.

The Flange enriches the OCTOPUS system: it hides the product so as to create a uniform and harmonious light effect. This reduces glare and light dispersion, improving visual quality and user comfort. Customizing the color of the product helps to give a touch of style and personality to the lighting system.

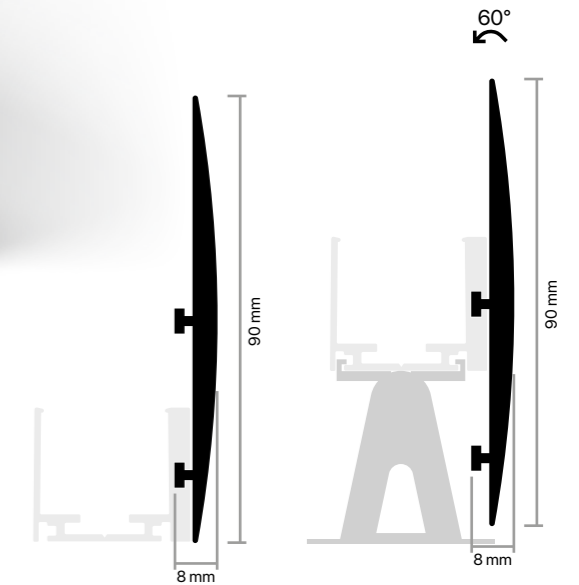

Accessori
Accessories



FL129/X - € 16,00
Supporto orientabile
Orientable support

Accessori
Accessories



FL129/X - € 16,00
Supporto orientabile
Orientable support

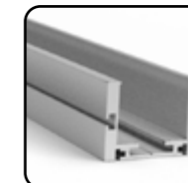

FL129/2 - € 55,00
Profilo Flangia Octopus
Octopus flange profile

Schermi da 10mt

Con i nuovi schermi da 10mt, potrai eliminare la fastidiosa interruzione tra due cover, migliorando l'estetica della realizzazione.

Questi diffusori sono realizzati in policarbonato e garantiscono un'uniforme distribuzione luminosa.

10m diffusers

With the new 10m screens, you will be able to eliminate the annoying interruption between two covers, improving the aesthetics of the creation.

These diffusers are made of polycarbonate and guarantee a uniform light distribution.

PR991/10 - Schermi da 10 metri PR991/10 - 10 meter covers

NEW

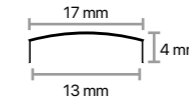

- Materiale in Policarbonato
- Colore Opale
- Lunghezza 10 metri
- Polycarbonate material
- Opal colour
- Length 10 meter

Profili compatibili Compatible profiles



Codice	Lunghezza	Colore	Listino
PR110	2 mt	Silver	€ 21,00

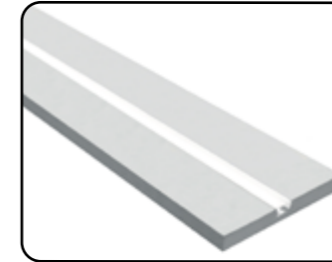

Codice	Lungh	Colore	Listino
PG110	2 mt	Cartongesso	€ 95,50

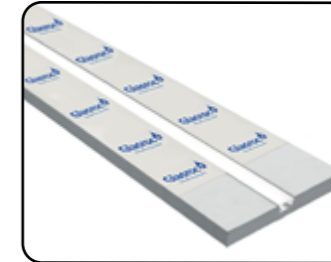

Codice	Lungh	Colore	Listino
PG110/GR	2 mt	Cartongesso	€ 201,50

PR925/10 - Schermi da 10 metri PR925/10 - 10 meter covers

NEW

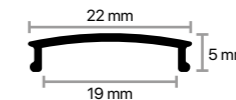

- Materiale in Policarbonato
- Colore Opale
- Lunghezza 10 metri
- Polycarbonate material
- Opal colour
- Length 10 meter

Profili compatibili Compatible profiles

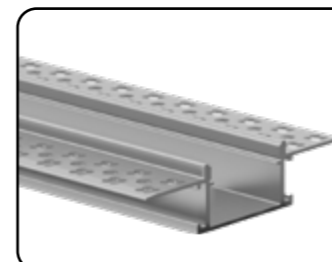

Codice	Lunghezza	Colore	Listino
PR225	2 mt	Silver	€ 50,00

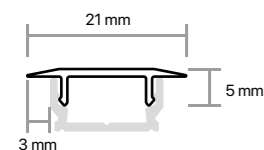

Le alette sporgenti di queste cover permettono di coprire le imperfezioni di fresatura per i profili installati ad incasso. In questo modo, si ottiene un effetto estetico più pulito e professionale, senza lasciare spazi vuoti tra il profilo e il supporto.

The protruding flaps of these covers allow you to cover the imperfections of milling for the profiles installed recessed. In this way, a cleaner and more professional aesthetic effect is obtained, without leaving empty spaces between the profile and the support.

Codice Code	Lunghezza Length	Colore Color	Listino Price
PR910/A	2 MT	Opale	€ 12,00
PR910/10A	10 MT	Opale	€ 60,00

Profili compatibili
Compatible profiles

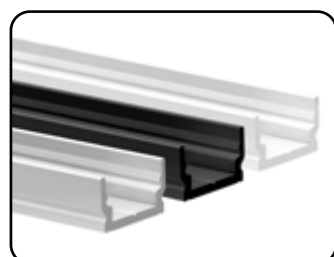

Codice	Lunghezza	Colore	Listino
PR101	2 mt	Silver	€ 19,00
PR101/NE	2 mt	Black	€ 22,50
PR101/BI	2 mt	White	€ 22,50
PR101/3	3 mt	Silver	€ 30,50
PR101/3NE	3 mt	Black	€ 34,00
PR101/3BI	3 mt	White	€ 34,00

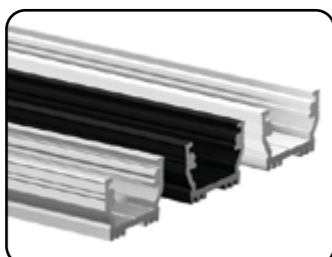

Codice	Lunghezza	Colore	Listino
PR500	2 mt	Silver	€ 23,00
PR500/NE	2 mt	Black	€ 26,00
PR500/BI	2 mt	White	€ 26,00

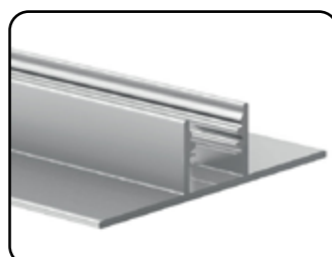

Codice	Lunghezza	Colore	Listino
PR221	2 mt	Silver	€ 30,50

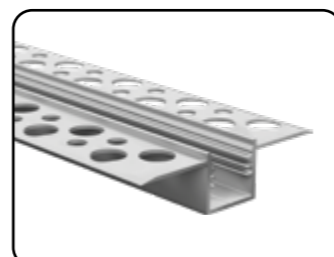

Codice	Lunghezza	Colore	Listino
PR223	2 mt	Silver	€ 38,00



Schermo standard
Standard cover

Schermo con alette
Cover with flaps

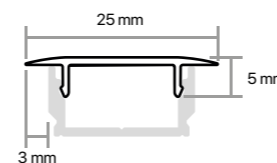
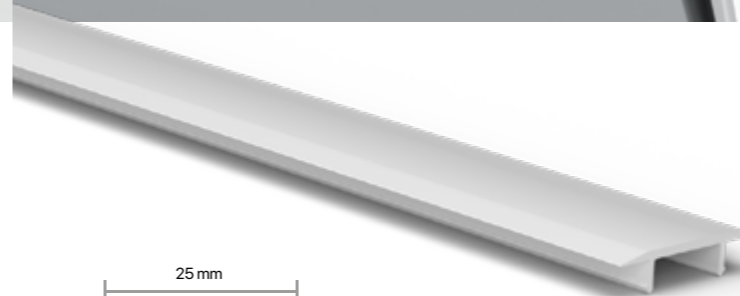

Le alette sporgenti di queste cover permettono di coprire le imperfezioni di fresatura per i profili installati ad incasso. In questo modo, si ottiene un effetto estetico più pulito e professionale, senza lasciare spazi vuoti tra il profilo e il supporto.

The protruding flaps of these covers allow you to cover the imperfections of milling for the profiles installed recessed. In this way, a cleaner and more professional aesthetic effect is obtained, without leaving empty spaces between the profile and the support.

Codice Code	Lunghezza Length	Colore Color	Listino Price
PR911/A	2 MT	Opale	€ 24,00
PR911/10A	10 MT	Opale	€ 110,00

Profili compatibili
Compatible profiles

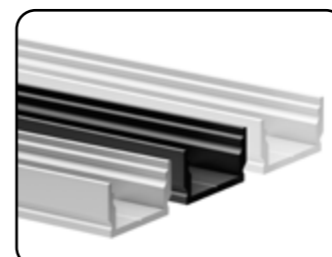

Codice	Lunghezza	Colore	Listino
PR115	2 mt	Silver	€ 22,50
PR115/NE	2 mt	Black	€ 25,50
PR115/BI	2 mt	White	€ 25,50

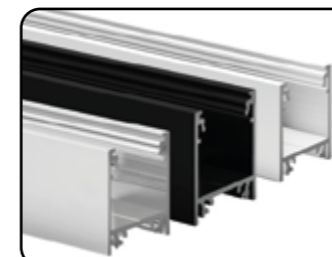

Codice	Lunghezza	Colore	Listino
PR120	2 mt	Silver	€ 30,00
PR120/NE	2 mt	Black	€ 44,50
PR120/BI	2 mt	White	€ 44,50

Centralina scale sequenziali

Con questo dispositivo è possibile gestire le luci dei gradini o dei corridoi in modo automatico e personalizzato. La centralina è dotata di un sensore di movimento che rileva la presenza di una persona sulle scale e attiva l'illuminazione dei gradini in sequenza, seguendo il senso di marcia. Si può impostare il numero di scalini, l'intensità e la velocità delle luci, creando effetti scenografici e garantendo la sicurezza. La semplicità di installazione e configurazione rendono questo prodotto la soluzione ideale per scale e corridoi più funzionali ed innovativi.

Sequential stairs control unit

With this device it is possible to manage the lights of the steps or corridors in an automatic and personalized way. The control unit is equipped with a movement sensor which detects the presence of a person on the stairs and activates the lighting of the steps in sequence, following the direction. You can set the number of steps, the intensity and speed of the lights, creating scenographic effects and guaranteeing safety. The simplicity of installation and configuration make this product the ideal solution for more functional and innovative stairs and corridors.



Centralina scale sequenziali
Sequential stairs control unit

NEW



CTS100 - Centralina scale sequenziali - € 310,00
Sequential stairs control unit

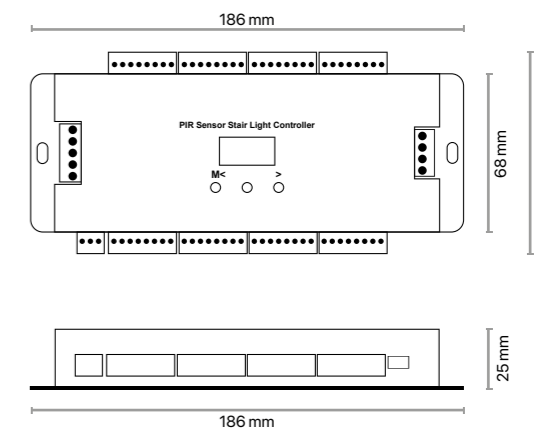

- Controller a 32 canali per illuminare in modo sequenziale scalinate, sentieri, viali e molto altro
- Compatibile con Strip Runner e Strip da 24V
- Funzionamento semplice con display OLED e 3 pulsanti
- Output: 32CH, 1A/CH
- 5-24V DC
- Funziona tramite 2 rilevatori IR (inclusi)
- Funziona tramite 2 pulsanti

- 32-channel controller for sequentially lighting stairways, paths, avenues and much more
- Compatible with Strip Runner and 24V Strip
- Simple operation with OLED display and 3 buttons
- Outputs: 32CH, 1A/CH
- 5-24V DC
- Works via 2 IR detectors (included)
- Works via 2 buttons



Accessori per Strip LED Runner
Accessories for Runner LED Strip



Per maggiori informazioni
scansiona
il QR Code

CT610
Centralina per Strip LED Runner - € 40,00
Control unit for Strip LED Runner

- Centralina miniaturizzata per Strip LED Runner azionabile tramite interruttore 0-1
- 4 modalità di funzionamento selezionabili
- Velocità e numero di pixel regolabili
- Max 5A (per lunghezza superiore, utilizzare l'amplificatore CT420)
- Miniaturized control unit for Strip LED Runner activated by 0-1 switch
- 4 selectable operating modes
- Adjustable speed and number of pixels
- Max 5A (for longer length, use CT420 amplifier)



Strip LED Runner
Runner LED Strip



Codice Code	IP IP	Consumo Power	W/MT W/MT	Temp. Temp.	Lumen Lumen	Lumen/MT Lumen/MT	DC DC	Listino Price
• SL120LBC20/R	20	60W	12W/MT	3000K	9500	1900	24V	€ 135,00
• SL120LBN20/R	20	60W	12W/MT	4000K	9750	1950	24V	€ 135,00
• SL120LBI20/R	20	60W	12W/MT	6000K	10100	2020	24V	€ 135,00

ACCESSORI
ACCESSORIES

CNT0515 - Connettore rapido
CNT0515 - Quick connector

NEW



Connettore singolo da 5mm per Strip LED SL125 IP20
con cavo di connessione da 15cm

Single 5mm connector for SL125 IP20 LED Strip
with 15cm connection cable

Codice Code	Listino Price
CNT0515	€ 2,00

CNT08 - Connettore rapido
CNT08 - Quick connector

NEW



Connettore rapido da 8mm per Strip LED SL120ES IP20

Quick 8mm connector for SL120ES IP20 LED Strip

Codice Code	Listino Price
CNT08	€ 2,00

CNT0815 - Connettore rapido
CNT0815 - Quick connector

NEW



Connettore singolo da 8mm per Strip LED SL120ES IP20
con cavo di connessione da 15cm

Single 8mm connector for SL120ES IP20 LED Strip
with 15cm connection cable

Codice Code	Listino Price
CNT0815	€ 2,00



A N N O 2 0 2 3

Catalogo Operativo





Sede / Headquarters

Via Nicola Ruffo, 27 - 70124 Bari - Italy

Tel. +39 080 504 6806

www.ledcoitalia.it | info@ledcoitalia.it