

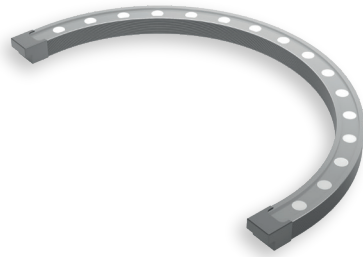

OCTOPUS

the twisted lighting

ISTRUZIONI
INSTRUCTIONS



CARATTERISTICHE DEL PRODOTTO

Prodotto IP65 resistente in ambienti esterni, ai raggi UV, alla corrosione da acidi e ad acqua clorata e salata.

La coestrusione siliconica e l'utilizzo di PCB indipendenti tra loro, rendono possibile il movimento 3D del prodotto (curvabile sia sull'asse verticale che su quella orizzontale).

Effetto Wall Washer.

Fascio d'apertura a 30° che garantisce uniformità luminosa e profondità di campo.

TENSIONE: 24V - La lunghezza massima per singolo punto di alimentazione è di 5mt.

PRODUCT FEATURES

IP65 product resistant to outdoor environments, UV rays, to corrosion by acids and chlorinated and salt water.

The silicone coextrusion and the use of independent PCBs make it possible the 3D movement of the product (bendable both on the vertical and on the horizontal axis).

Wallwash effect.

30° opening beam which guarantees luminous uniformity and depth of field.

VOLTAGE: 24V - The maximum length for a single power supply point is 5mt.

DIMENSIONI PRODOTTO

PRODUCT DIMENSION

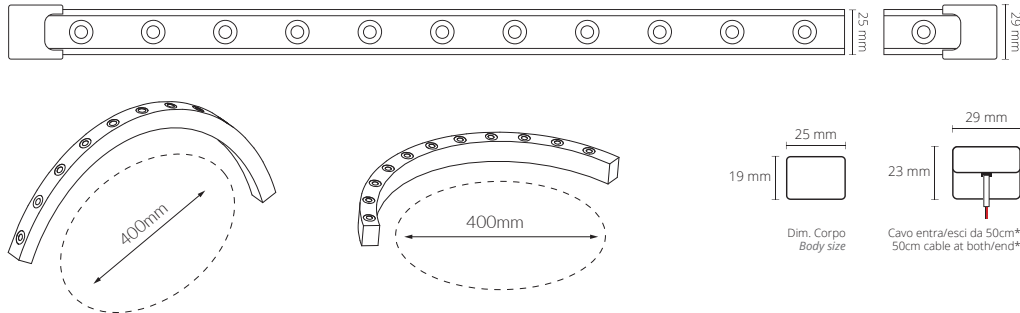

INSTALLAZIONE INSTALLATION

Clip in alluminio
Aluminum Clip

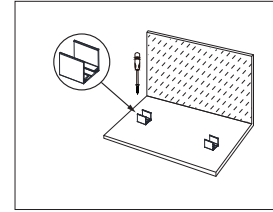

Fissare le clip in alluminio alla superficie di montaggio con il cacciavite.
Fix the aluminum clips to the mounting surface with the screwdriver.

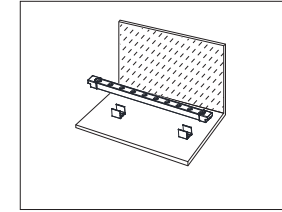

Fissare la OCTOPUS sulla clip.
Clamp the OCTOPUS on the aluminum clips.

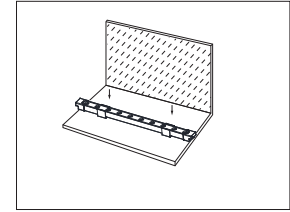

Accendere.
Turn on the power.

Profilo in alluminio
Aluminum profile

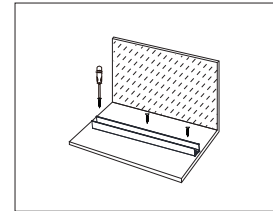

Fissare il profilo in alluminio alla superficie di montaggio con il cacciavite.
Fix the aluminum profile to the mounting surface with the screwdriver.

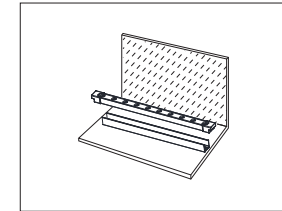

Fissare la OCTOPUS sul profilo.
Clamp the OCTOPUS on the profile.

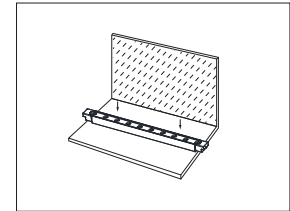

Accendere.
Turn on the power

Supporto orientabile
+ Clip in alluminio
Orientable support
+ Aluminum clip

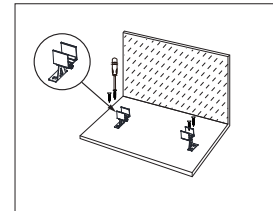

Fissare i supporti orientabili alla superficie di montaggio con il cacciavite, quindi fissare le clip ai supporti orientabili.
Fix the adjustable angle clips to the mounting surface with the screwdriver, then fix the aluminum clips on to the adjustable angle clips.

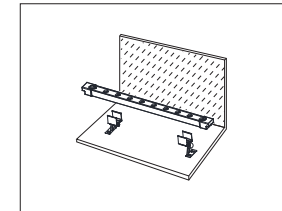

Fissare la OCTOPUS sulle clip.
Clamp the OCTOPUS on the clips.

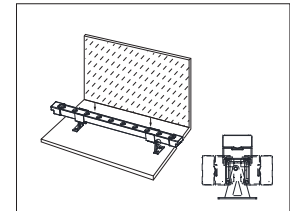

Regolare l'angolazione e accendere.
Adjust the angle and turn on.

Supporto orientabile
+ Profilo in alluminio
Orientable support
+ Aluminum profile

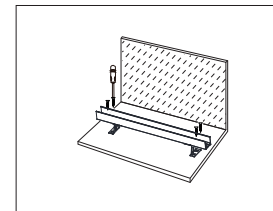

Fissare i supporti orientabili alla superficie di montaggio con il cacciavite, quindi fissare il profilo ai supporti orientabili.
Fix the adjustable angle clips to the mounting surface with the screwdriver, then fix the aluminum profile on to the adjustable angle clips.

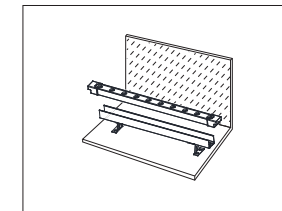

Fissare la OCTOPUS sul profilo.
Clamp the OCTOPUS on the profile.

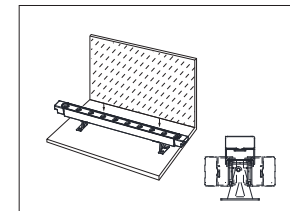

Regolare l'angolazione e accendere.
Adjust the angle and turn on.